

Moj prvi srednjevalovni  
radijski sprejemnik  
(1972)



Moj prvi UKV  
radijski sprejemnik  
Moj prvi članek  
Radioamater 1975





Laboratorijski napajalnik  
8V...24V / 1A

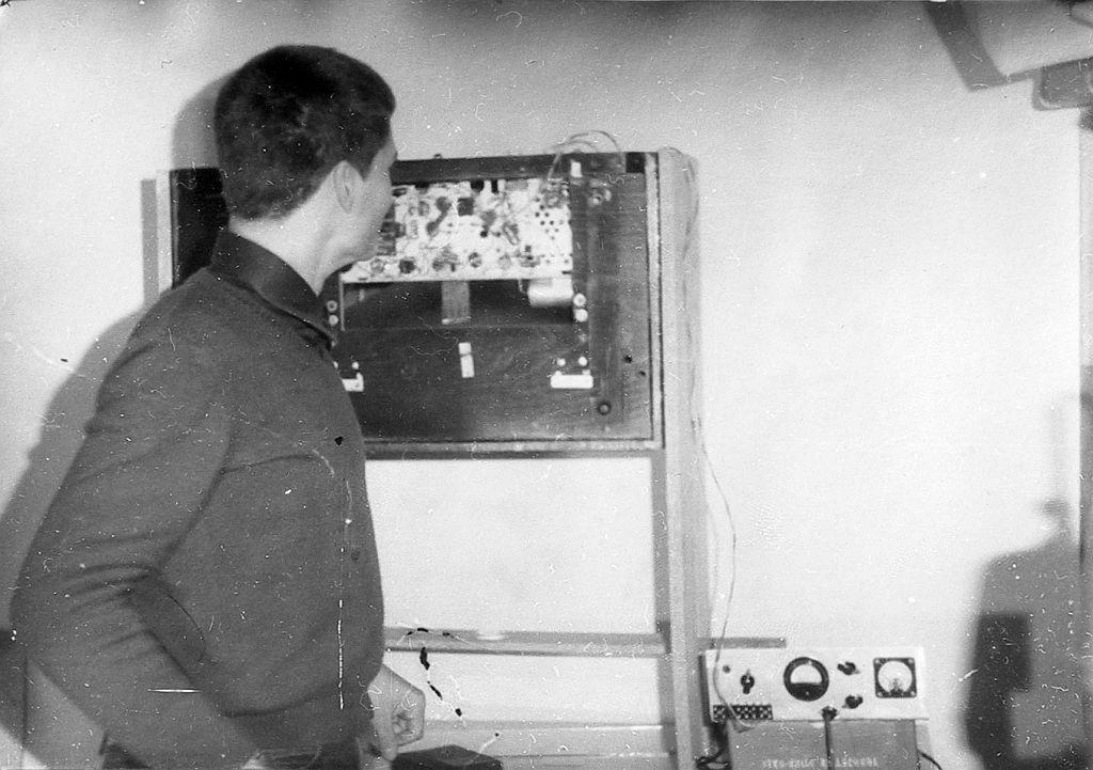

Sovjetski satelit  
Meteor 1  
(1978)



Osciloskop 5MHz  
1978 (zgoraj)

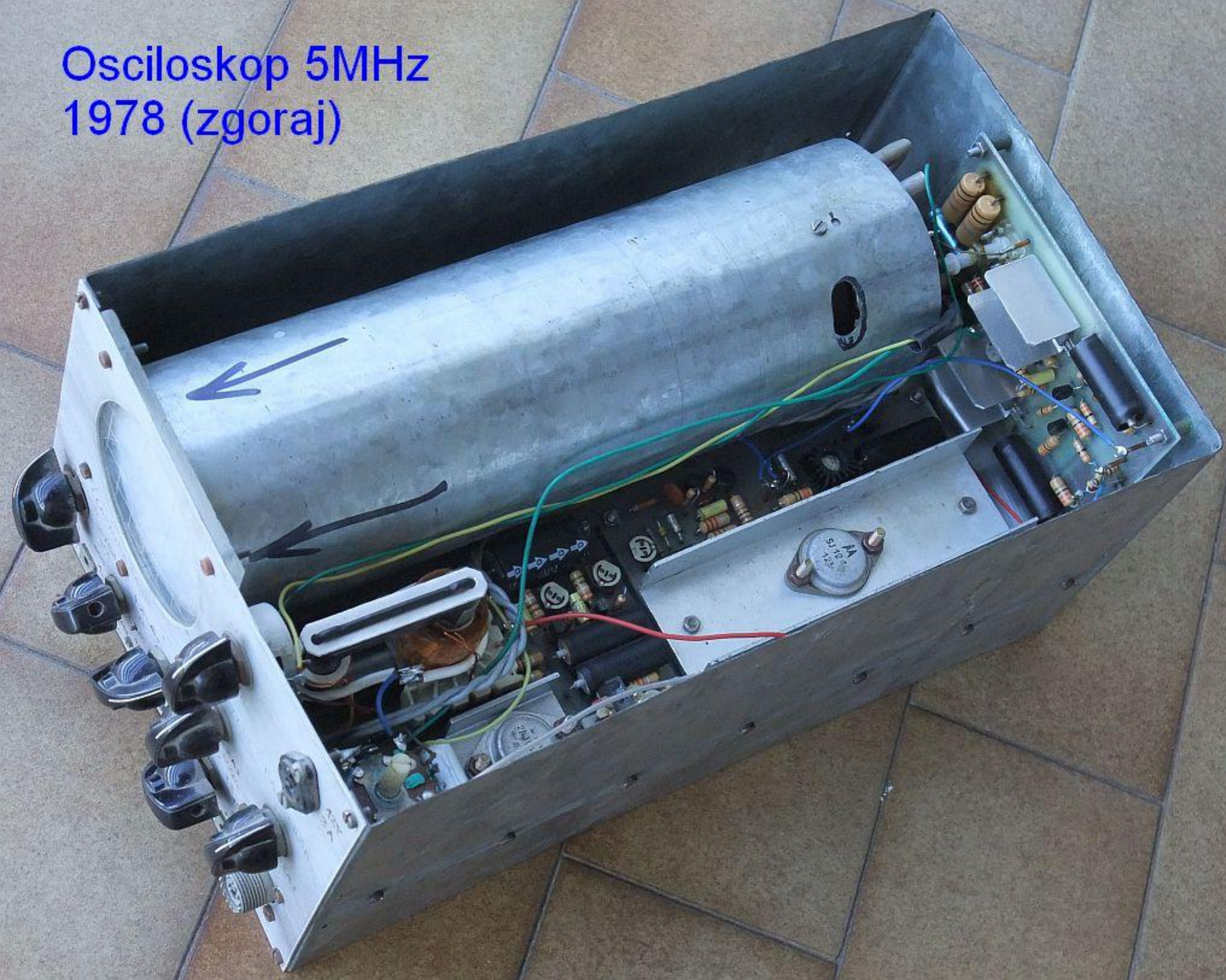

Osciloskop 5MHz  
1978 (spodaj)



# Oscilloskop 5MHz 1978

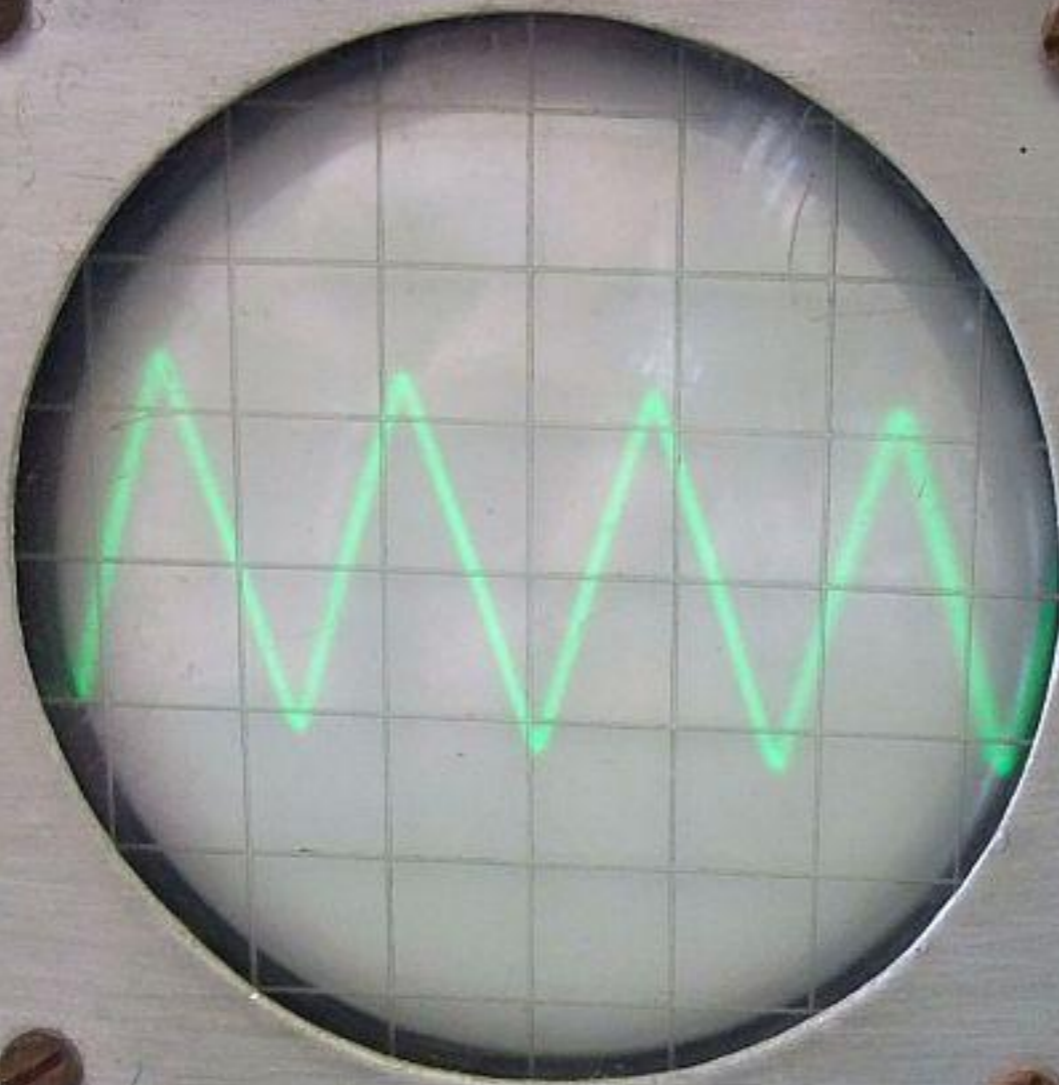

DES. - LEV.

DOL. - DR.



ČASOVNA VÁZKA

X F

Y F



4 MS/div

400 5 3 22

15

100V

MS/div

200V/div

V/div

Y VRO





Slikovni pomnilnik  
192x128x3bit  
(1979)

Zrcalo 2.4m za 1.7GHz  
(1979)





Ročna FM radijska postaja  
145MHz / 0.5uV RX / 1W TX  
(1979)

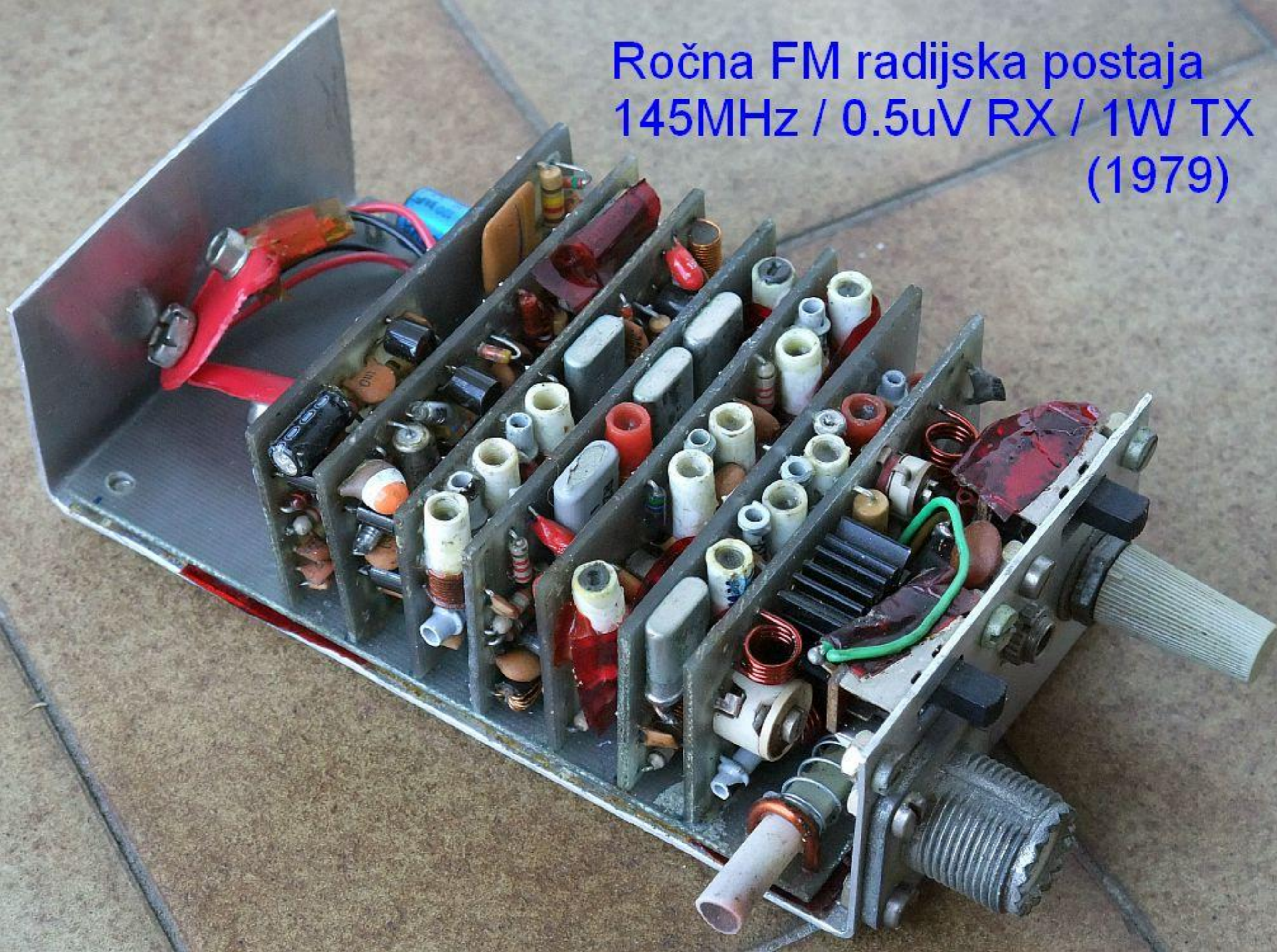

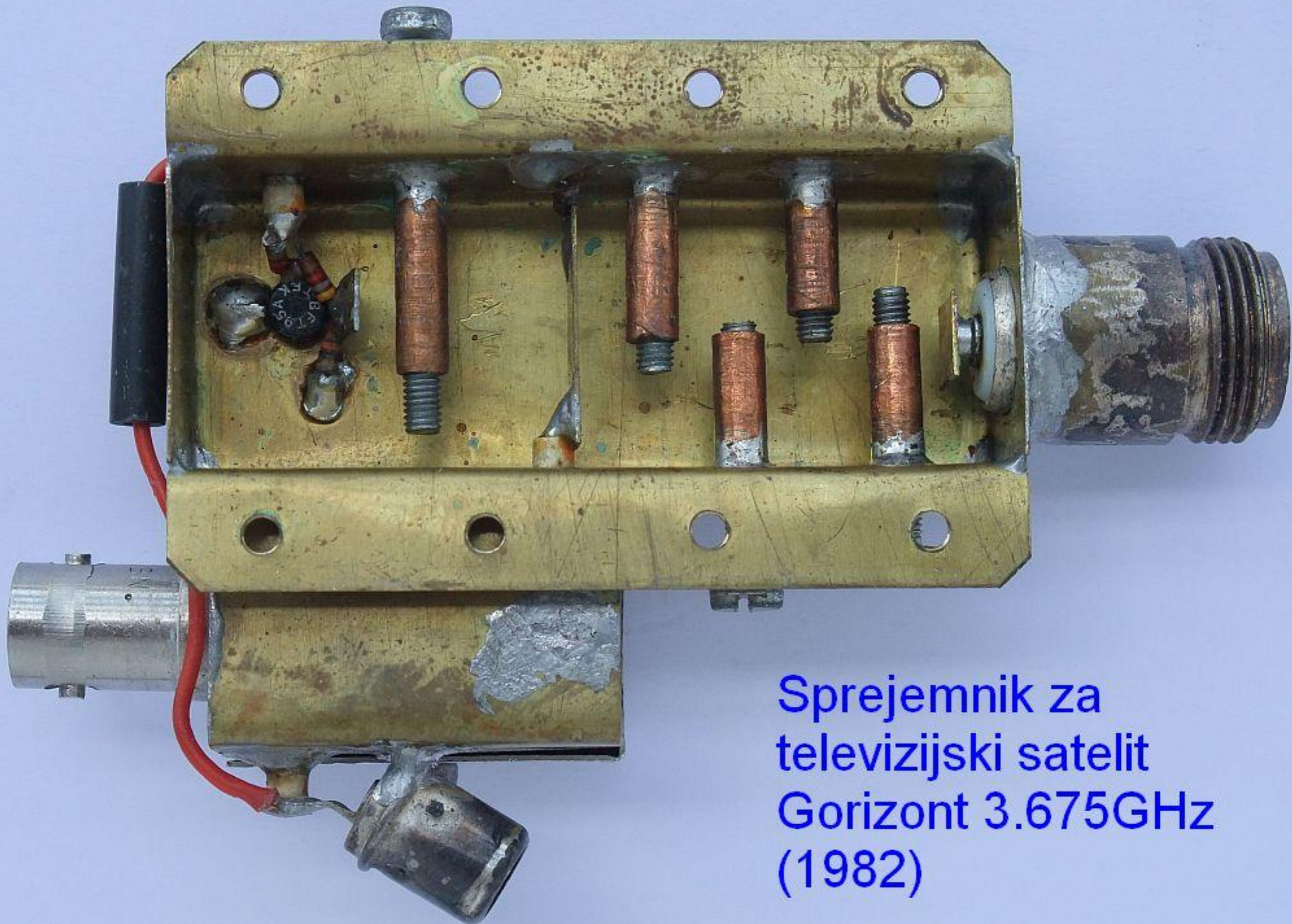

Sprejemnik za  
televizijski satelit  
Gorizont 3.675GHz  
(1982)

"APT scan converter"  
256x256x6bit (1982)

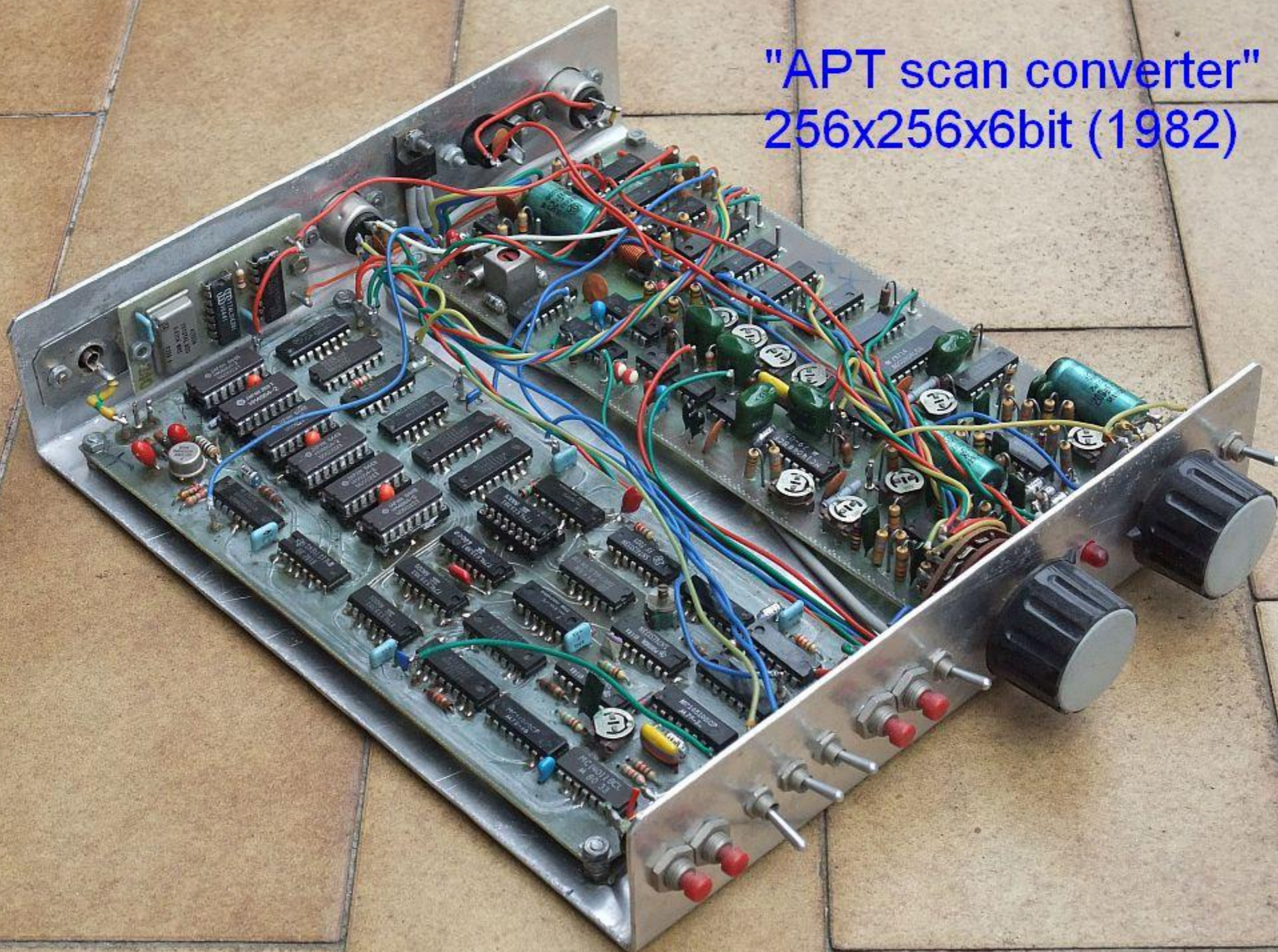

Satelitska TV  
(1985)



Sprejemnik za satelitsko TV  
10.9GHz...11.7GHz NF=4dB  
(1985)







Sat-TV drugo mešanje 0.8GHz-1.8GHz (1985)

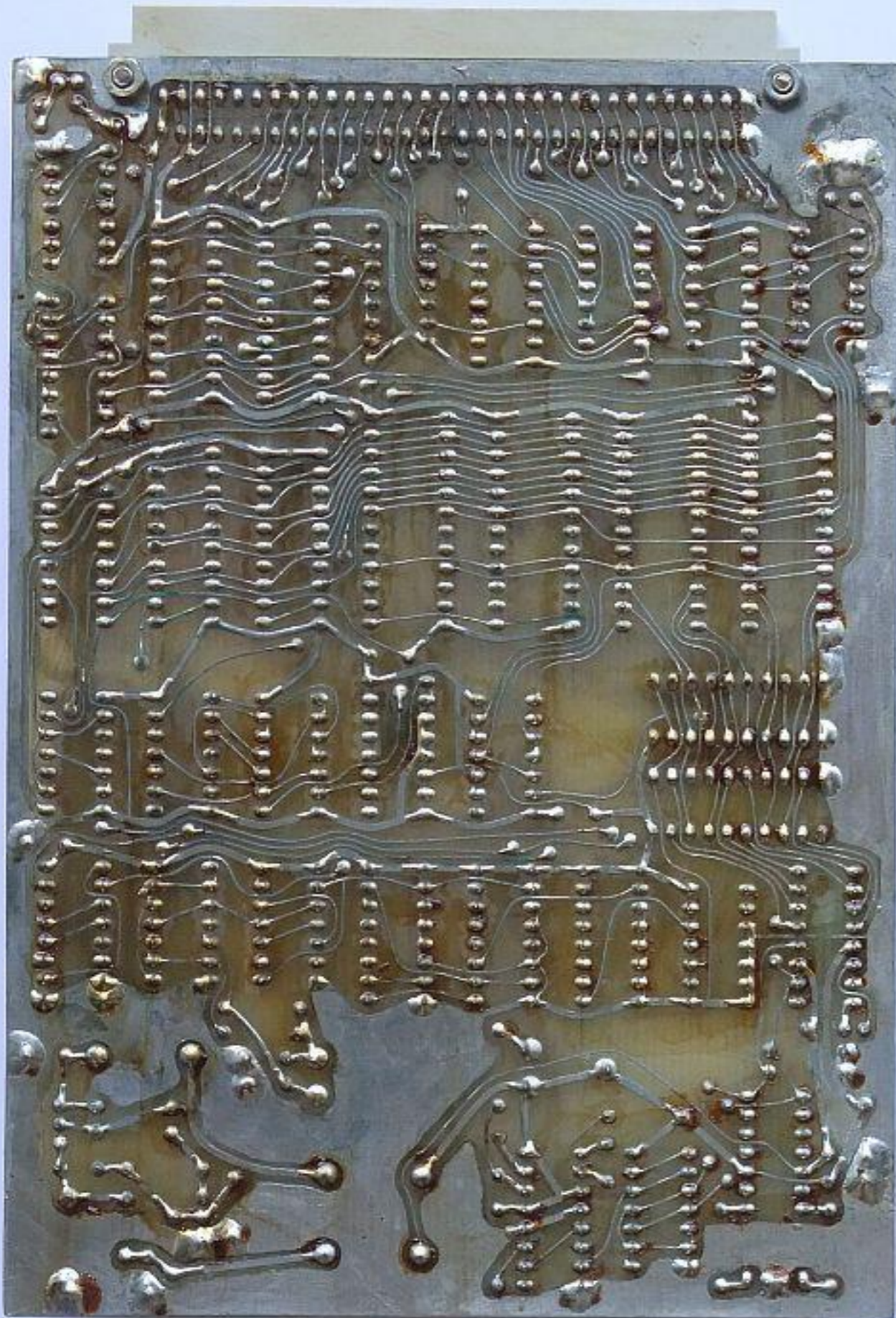

Video

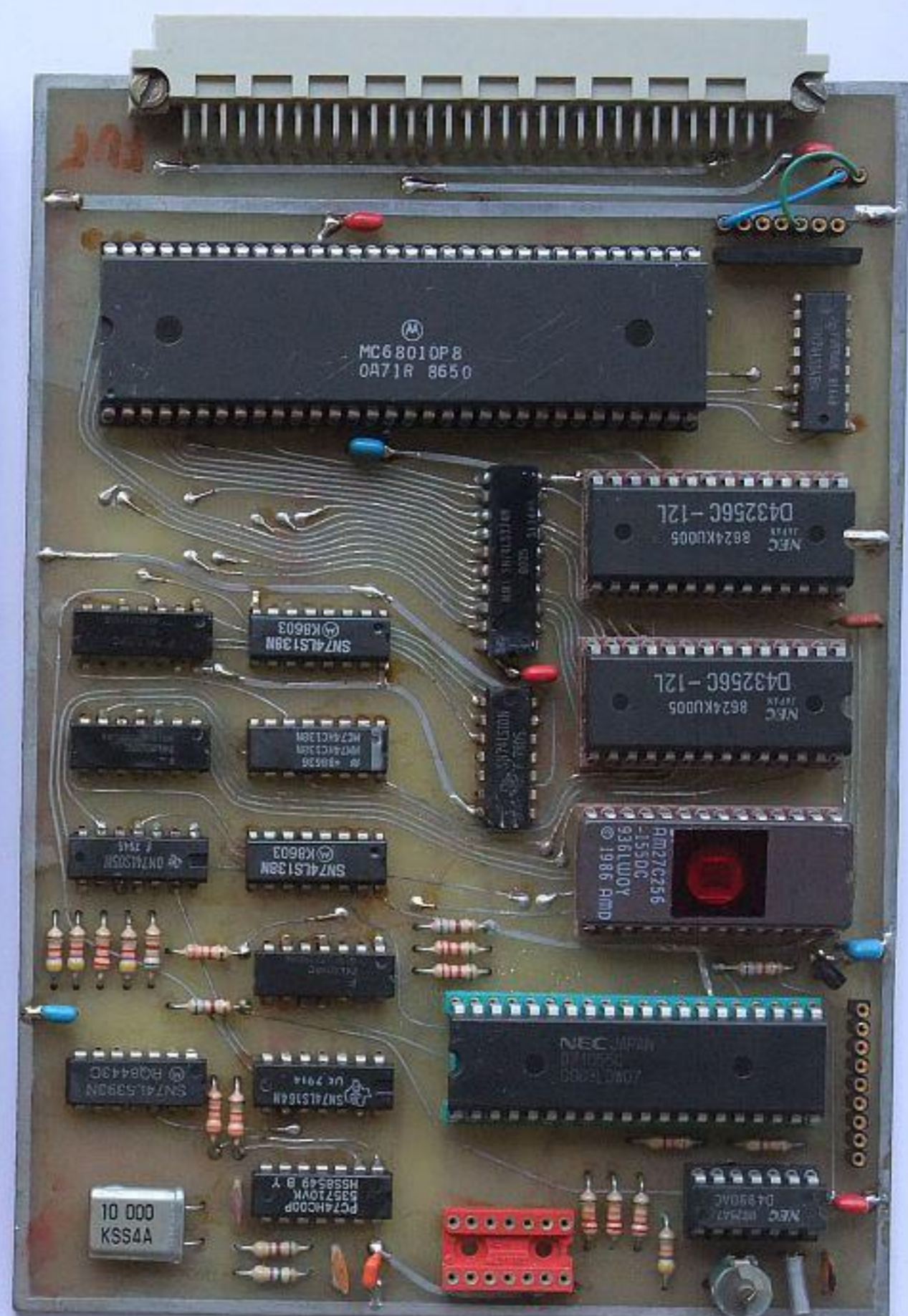

Računalnik z MC68010 (1986)

CPU



Računalnik z MC68010 (1986)

Satellite :  
GPSB11A-22

Altitude :  
20023km



43.9N  
57.1E

9 26 38  
16 10 2009

**Računalnik z MC68010 (1986)**



Nizkošumni  $F=0.5\text{dB}$  ojačevalnik za  $2.4\text{GHz}$  (1990)

Moduli za satelite Microsat (1990)

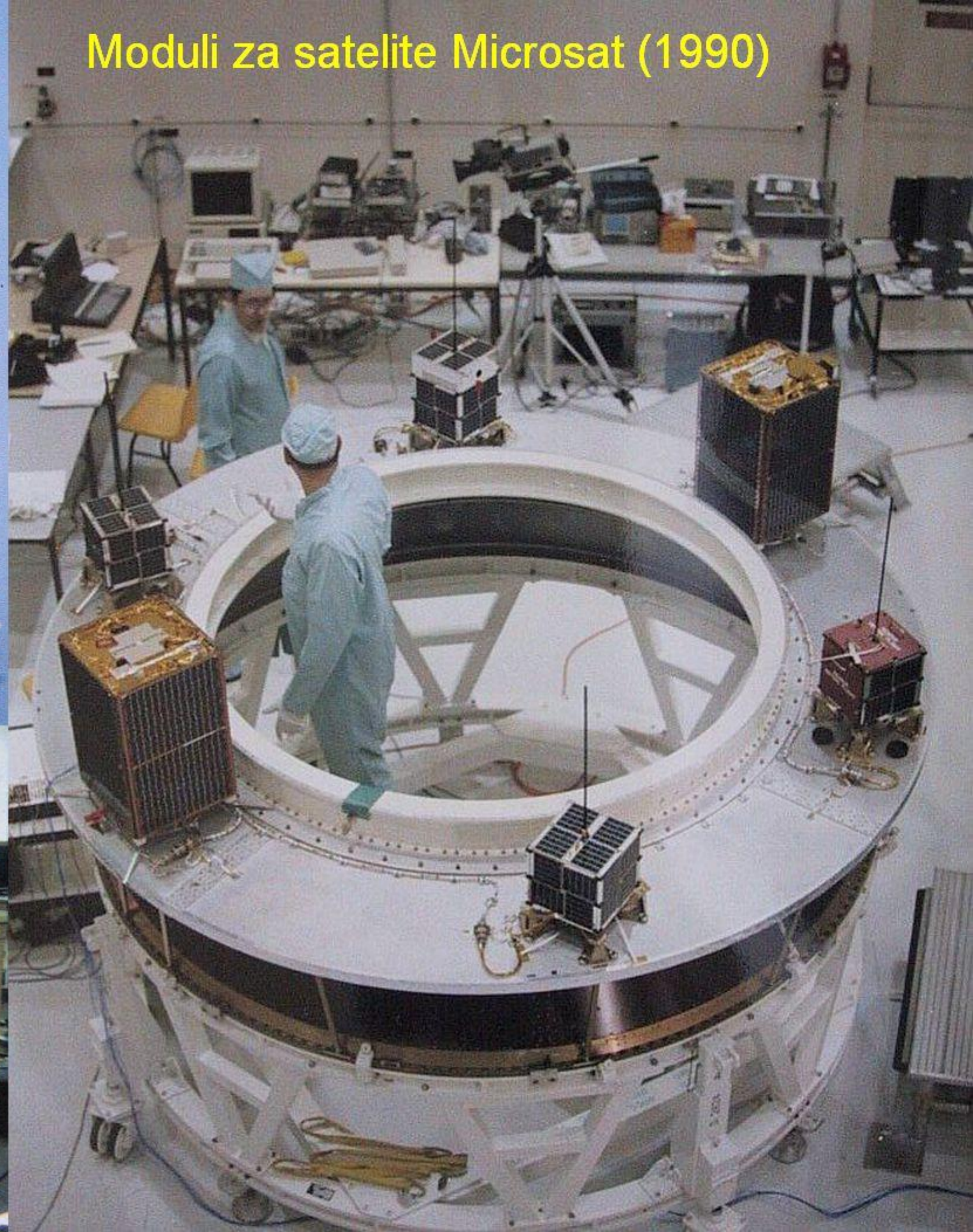
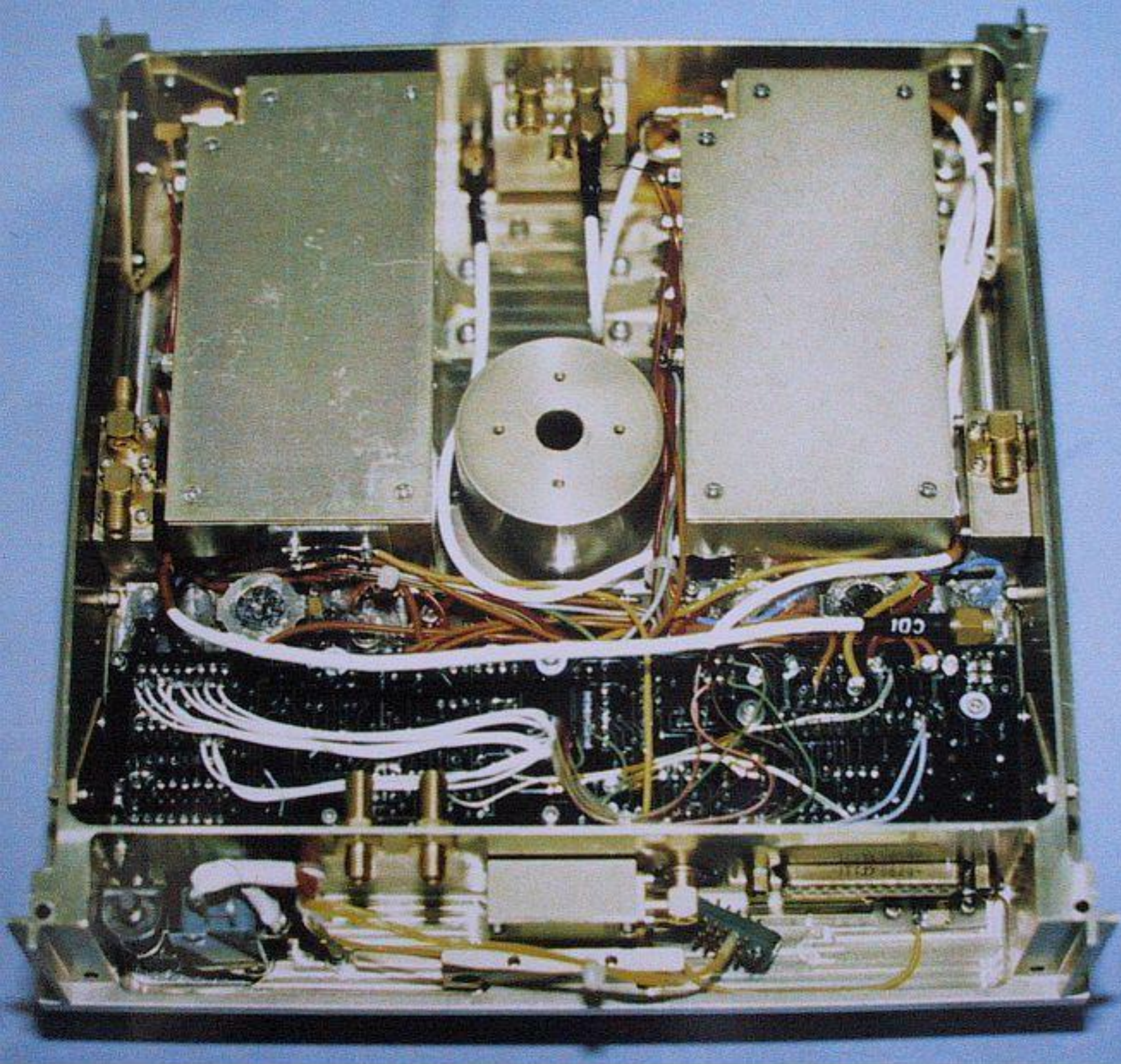

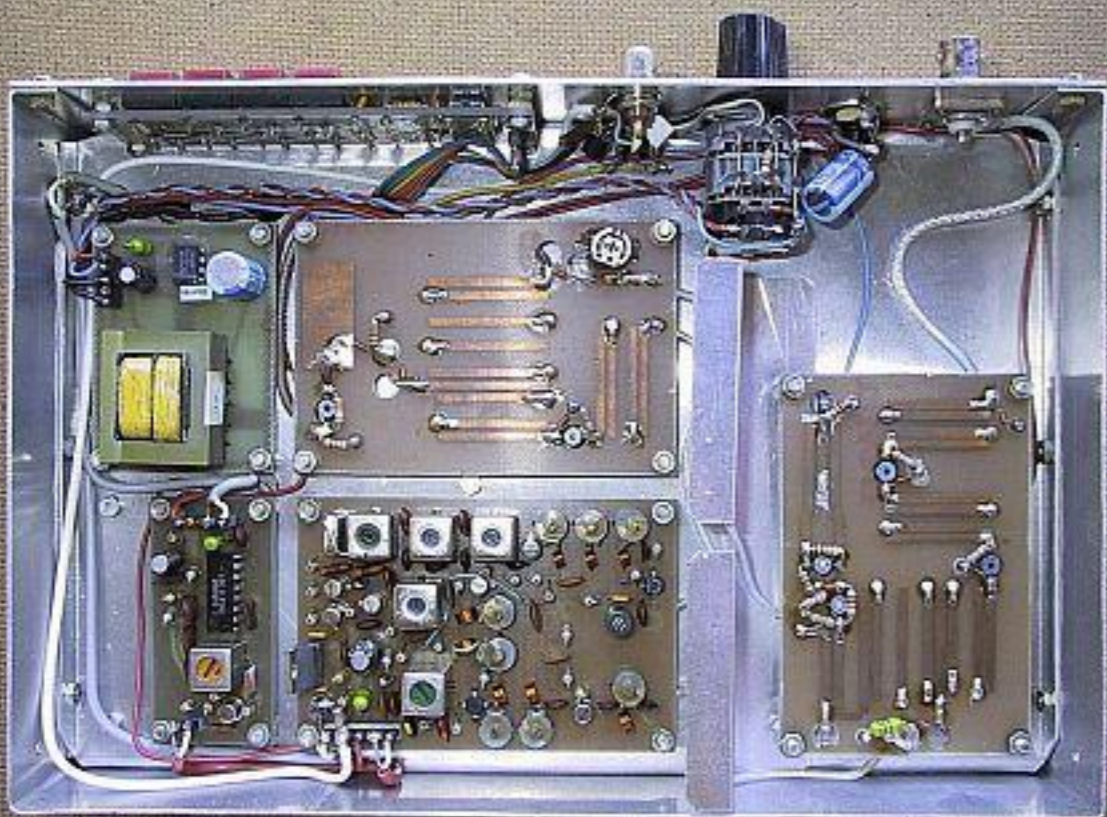
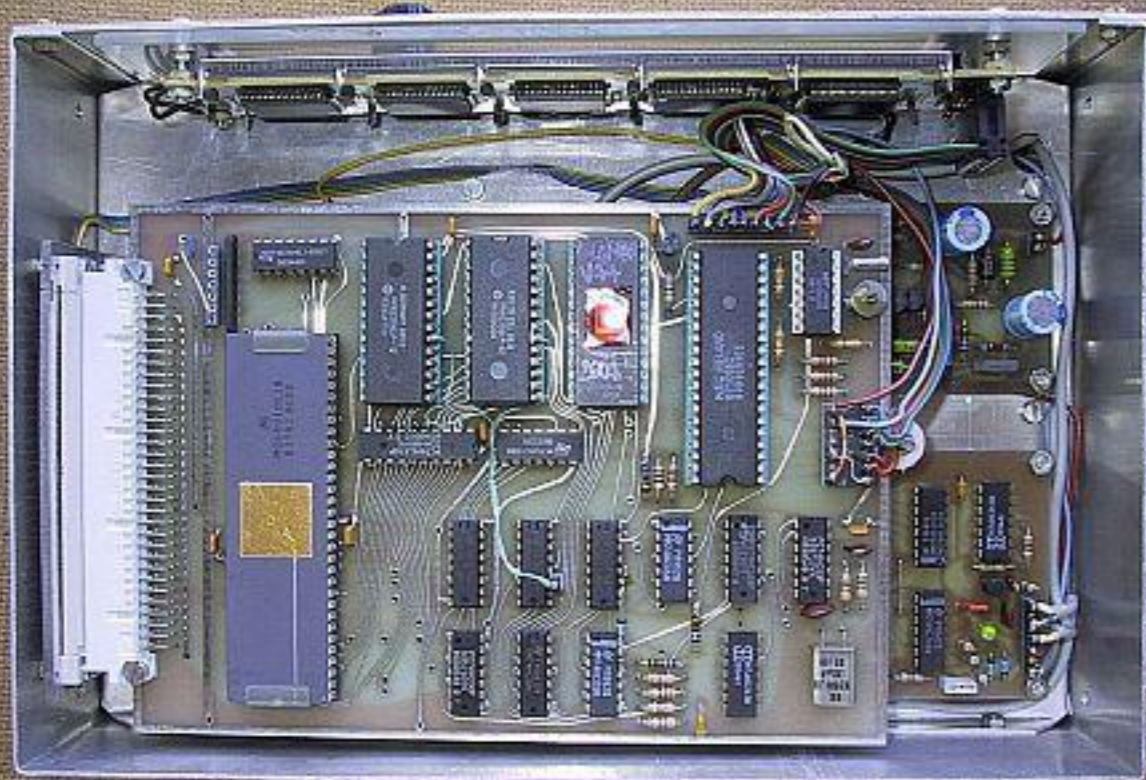

**Sprejemnika za GLONASS in GPS (1992)**

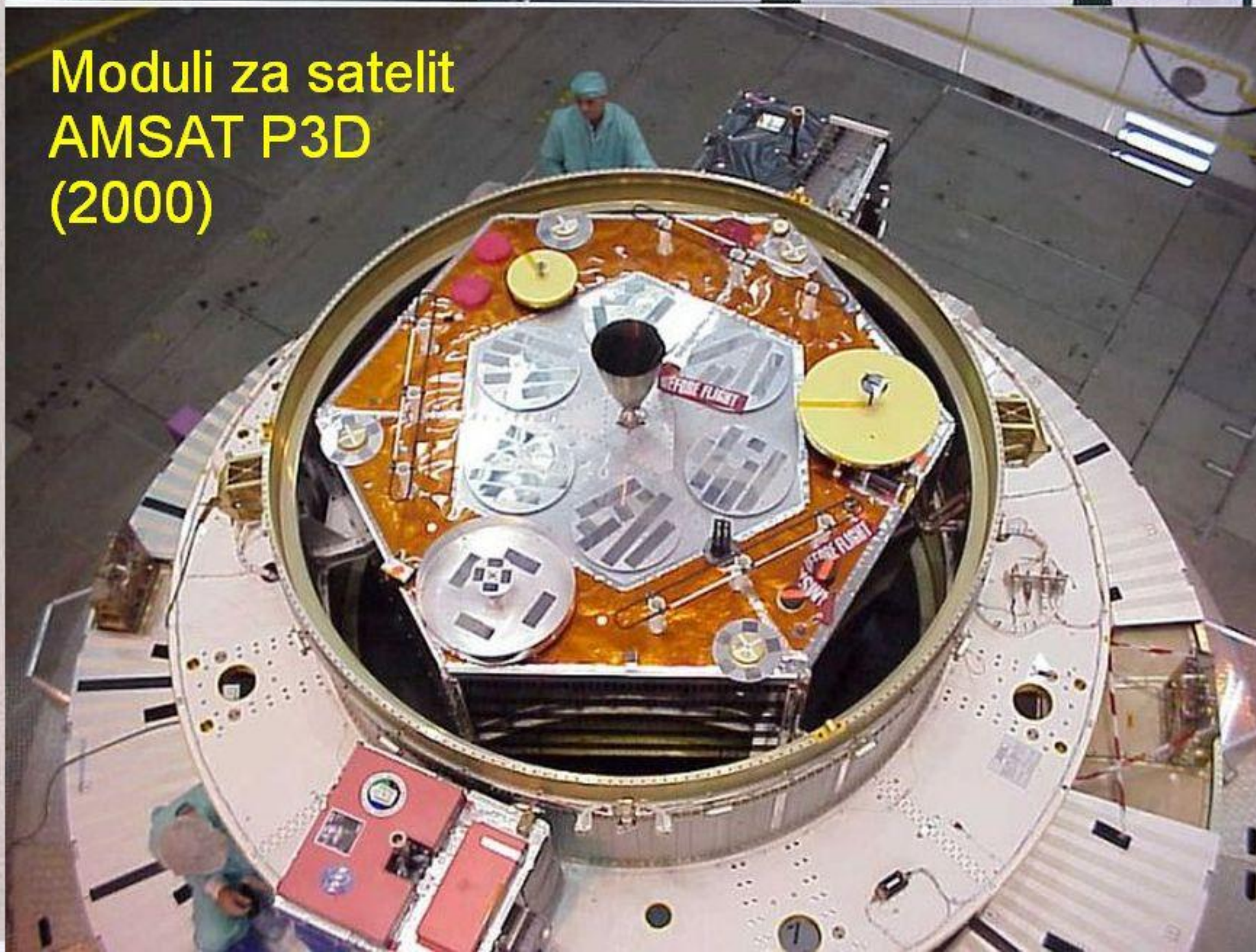
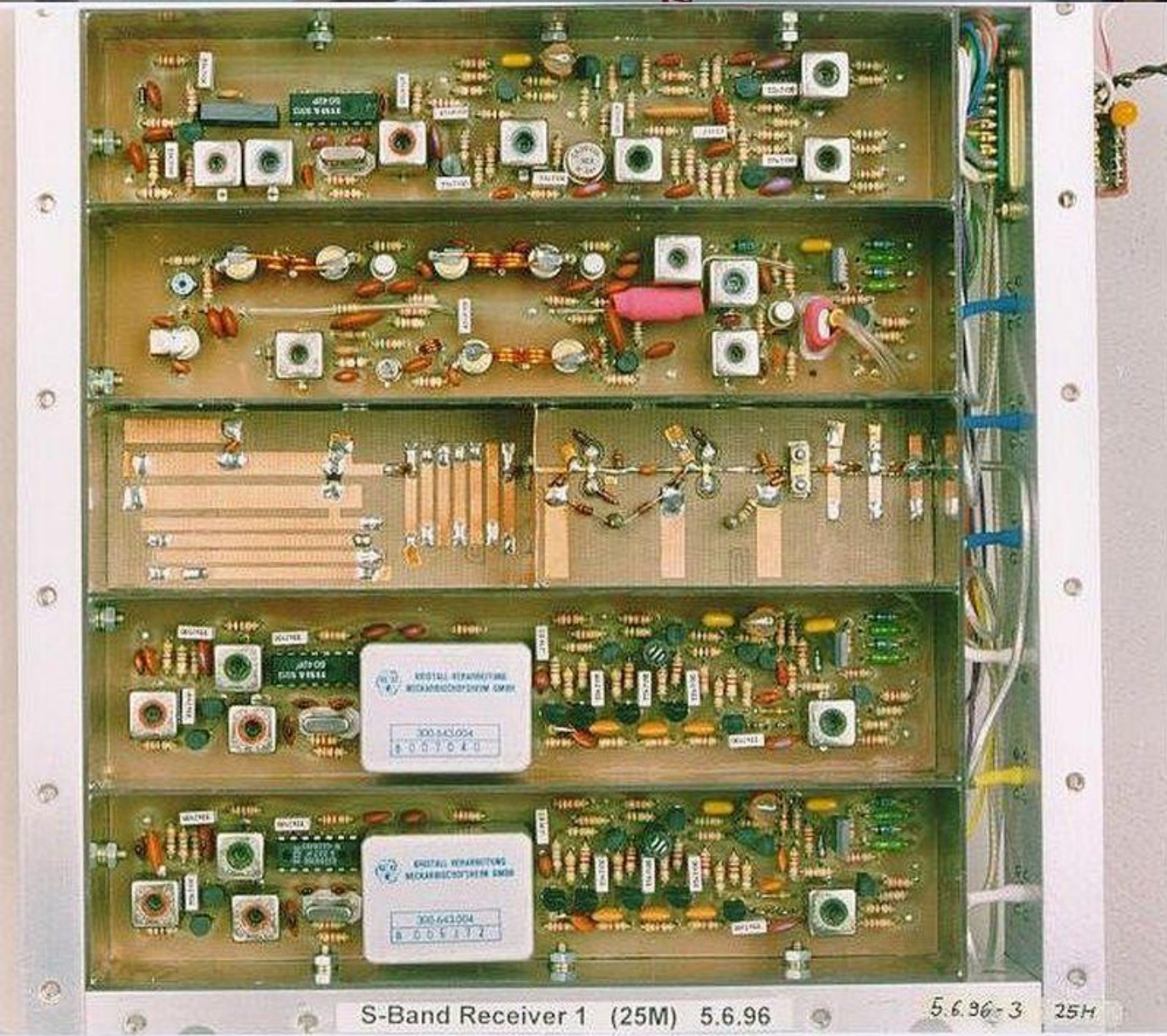
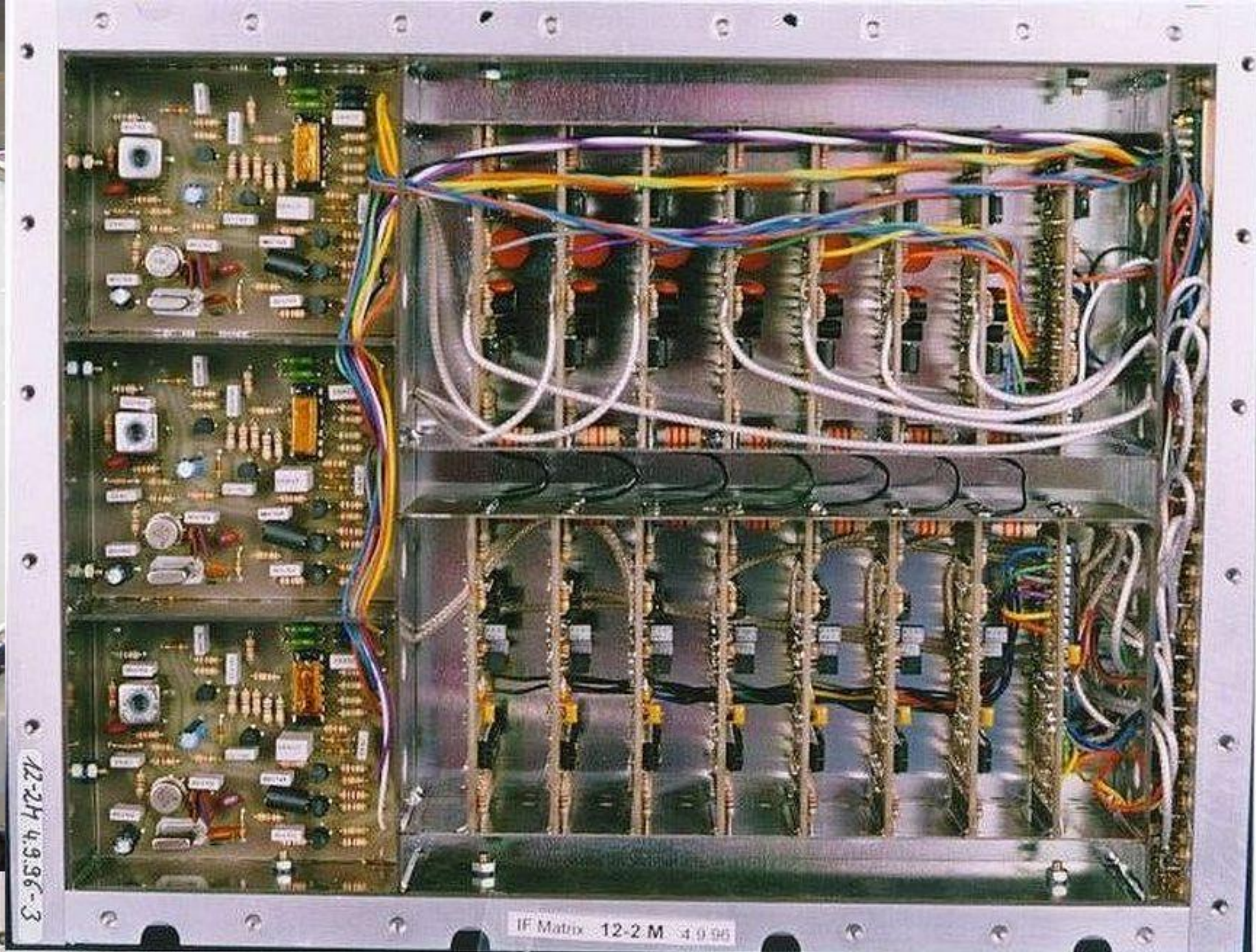
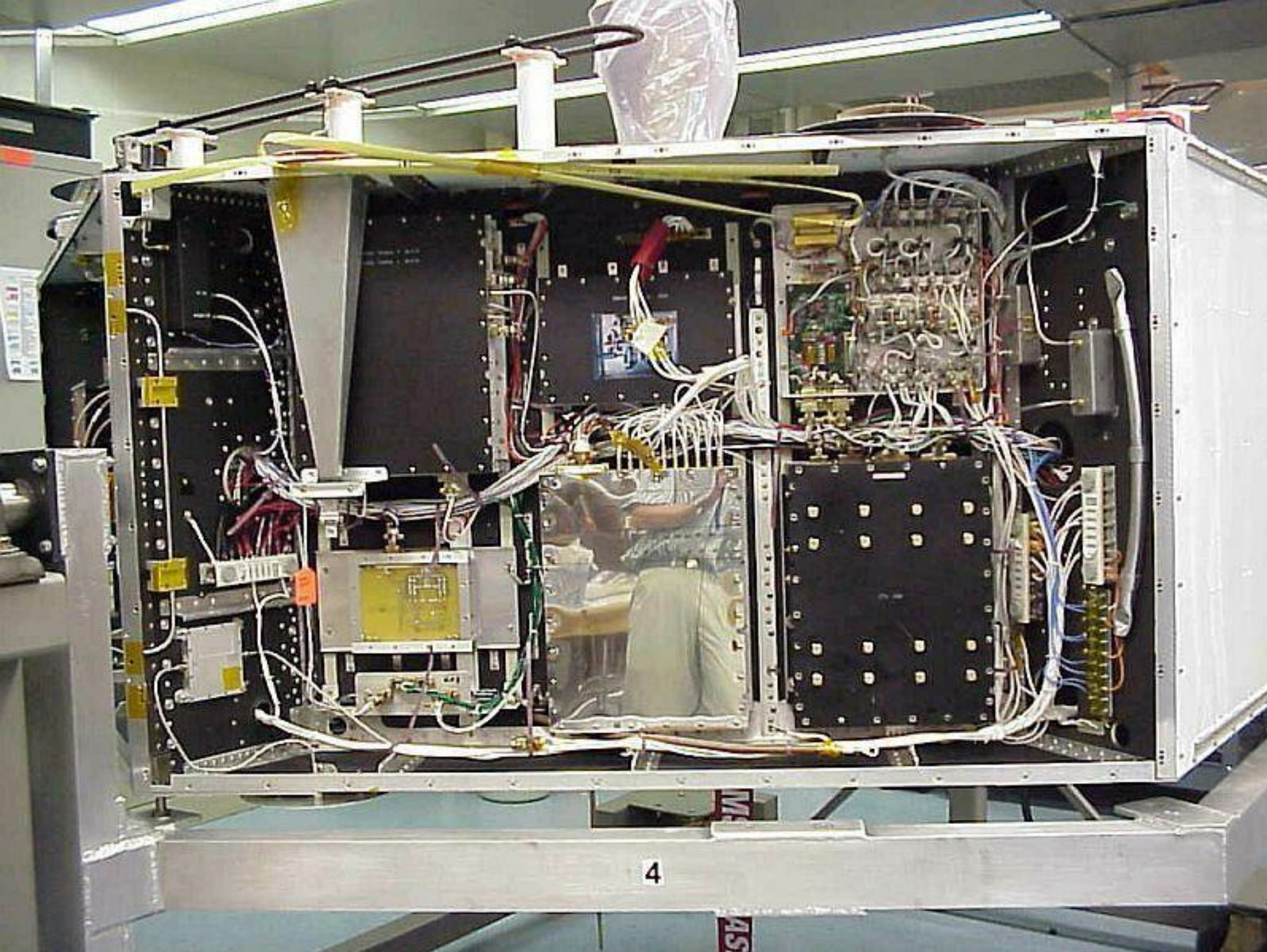



Spektralni analizator 0...1750MHz (1997)





ZIF-BPSK 23cm

**Radijska postaja 1.2Mbps z ničelno medfrekvenco (1996)**

KISS/SLIP TNC

Modem 1.2Mbps  
TCP/IP via AX.25  
(1999)

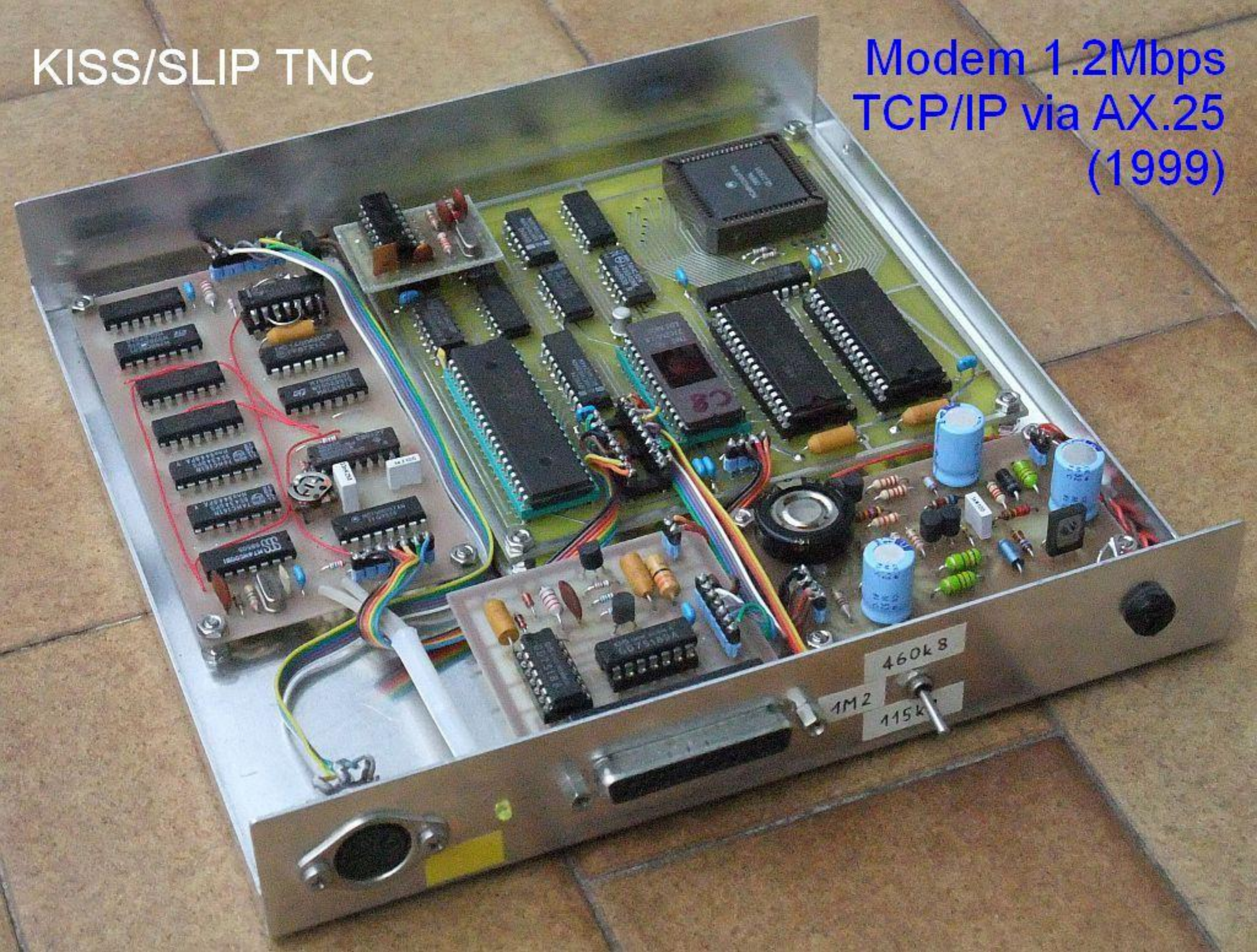

# S5 Amateur AX.25 radio network

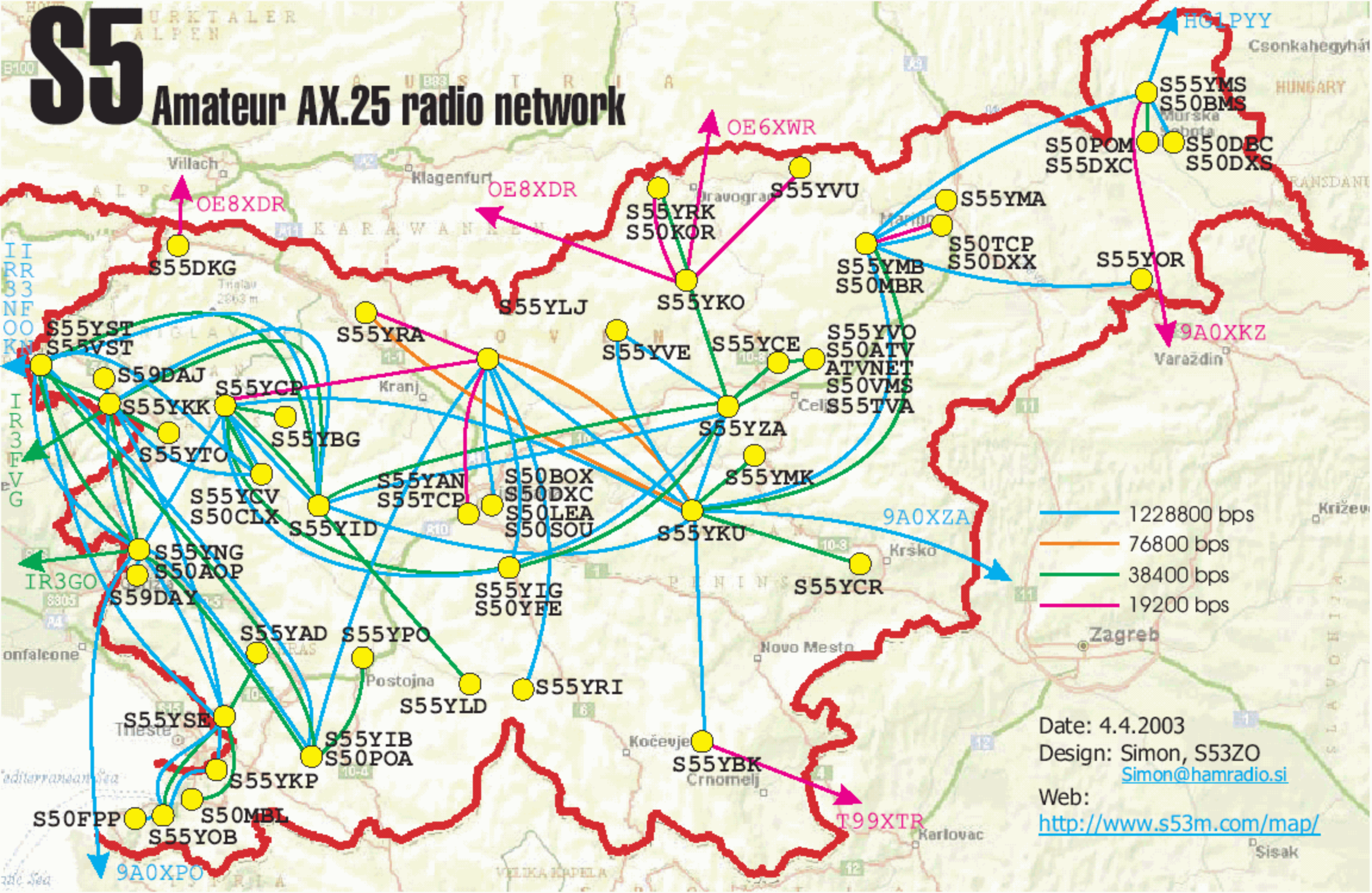

- 1228800 bps
- 76800 bps
- 38400 bps
- 19200 bps

Date: 4.4.2003  
 Design: Simon, S53ZO  
[Simon@hamradio.si](mailto:Simon@hamradio.si)  
 Web:  
<http://www.s53m.com/map/>

# S5

## Amateur AX.25 radio network

IR33NF00KN  
IR33FVG  
IR3GO

IR3GO

9A0XPO

OE8XDR

OE8XDR

OE6XWR

HG1PYY

9A0XKZ

9A0XZA

T99XTR

S55DKG

S55YST  
S55VST

S59DAJ

S55YKK

S55YTO

S55YCV

S55YNG

S50AOP

S59DAY

S55YSE

S55YAD

S55YIB

S55YKP

S50FPP

S55YOB

S50MBL

S55YOB

S55YRA

S55YCP

S55YBG

S55YCV

S55YAN

S55YID

S55YAD

S55YPO

S55YIB

S55YKP

S55YIB

S50POA

S55YIB

S55YIB

S55YIB

S55YIB

S55YLJ

S55YRA

S55YCP

S55YBG

S55YCV

S55YAN

S55YID

S55YAD

S55YPO

S55YIB

S55YKP

S55YIB

S55YKP

S55YIB

S55YIB

S55YIB

S55YIB

S55YRK

S50KOR

S55YKO

S55YVE

S55YAN

S55YID

S55YAD

S55YPO

S55YIB

S55YKP

S55YIB

S55YKP

S55YIB

S55YKP

S55YIB

S55YKP

S55YIB

S55YKP

S55YIB

S55YKP

S55YVU

S55YKO

S55YVE

S55YAN

S55YID

S55YAD

S55YPO

S55YIB

S55YKP

S55YIB

S55YKP

S55YIB

S55YKP

S55YIB

S55YKP

S55YIB

S55YKP

S55YIB

S55YKP

S55YIB

S55YKP

S55YMB

S50MBR

S55YKO

S55YVE

S55YAN

S55YID

S55YAD

S55YPO

S55YIB

S55YKP

S55YIB

S55YKP

S55YIB

S55YKP

S55YIB

S55YKP

S55YIB

S55YKP

S55YIB

S55YMA

S50TCP

S50DXX

S55YKO

S55YVE

S55YAN

S55YID

S55YAD

S55YPO

S55YIB

S55YKP

S55YIB

S55YKP

S55YIB

S55YKP

S55YIB

S55YKP

S55YIB

S55YKP

S55YIB

S55YKP

- 1228800 bps
- 76800 bps
- 38400 bps
- 19200 bps

Date: 4.4.2003  
 Design: Simon, S53ZO  
[Simon@hamradio.si](mailto:Simon@hamradio.si)  
 Web:  
<http://www.s53m.com/map/>

IR33NF00KN  
IR33FVG  
IR3GO

IR3GO

9A0XPO

OE8XDR

OE8XDR

OE6XWR

HG1PYY

9A0XKZ

9A0XZA

T99XTR

S55DKG

S55YST  
S55VST

S59DAJ

S55YKK

S55YTO

S55YCV

S55YNG

S50AOP

S59DAY

S55YSE

S55YAD

S55YIB

S55YKP

S50FPP

S55YOB

S50MBL

S55YOB

S55YRA

S55YCP

S55YBG

S55YCV

S55YAN

S55YID

S55YAD

S55YPO

S55YIB

S55YKP

S55YIB

S55YKP

S55YIB

S55YKP

S55YIB

S55YKP

S55YLJ

S55YRA

S55YCP

S55YBG

S55YCV

S55YAN

S55YID

S55YAD

S55YPO

S55YIB

S55YKP

S55YIB

S55YKP

S55YIB

S55YKP

S55YIB

S55YKP

S55YRK

S50KOR

S55YKO

S55YVE

S55YAN

S55YID

S55YAD

S55YPO

S55YIB

S55YKP

S55YIB

S55YKP

S55YIB

S55YKP

S55YIB

S55YKP

S55YIB

S55YKP

S55YIB

S55YKP

S55YVU

S55YKO

S55YVE

S55YAN

S55YID

S55YAD

S55YPO

S55YIB

S55YKP

S55YIB

S55YKP

S55YIB

S55YKP

S55YIB

S55YKP

S55YIB

S55YKP

S55YIB

S55YKP

S55YIB

S55YKP

S55YMB

S50MBR

S55YKO

S55YVE

S55YAN

S55YID

S55YAD

S55YPO

S55YIB

S55YKP

S55YIB

S55YKP

S55YIB

S55YKP

S55YIB

S55YKP

S55YIB

S55YKP

S55YIB

S55YMA

S50TCP

S50DXX

S55YKO

S55YVE

S55YAN

S55YID

S55YAD

S55YPO

S55YIB

S55YKP

S55YIB

S55YKP

S55YIB

S55YKP

S55YIB

S55YKP

S55YIB

S55YKP

# Samogradnja avionike



# Radarski višinomer 4.3GHz (2008)

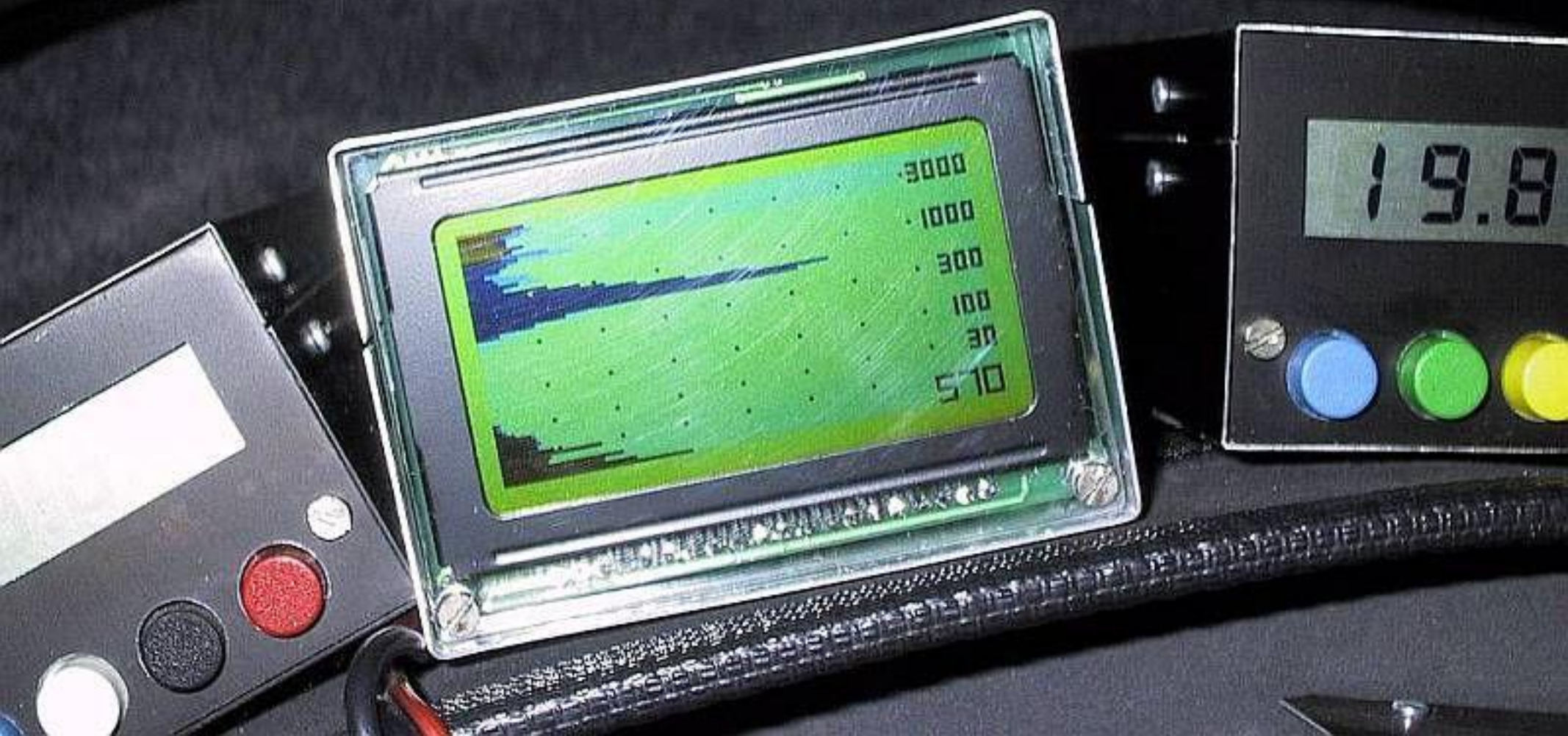

S55YCP

Črna prst 1844m



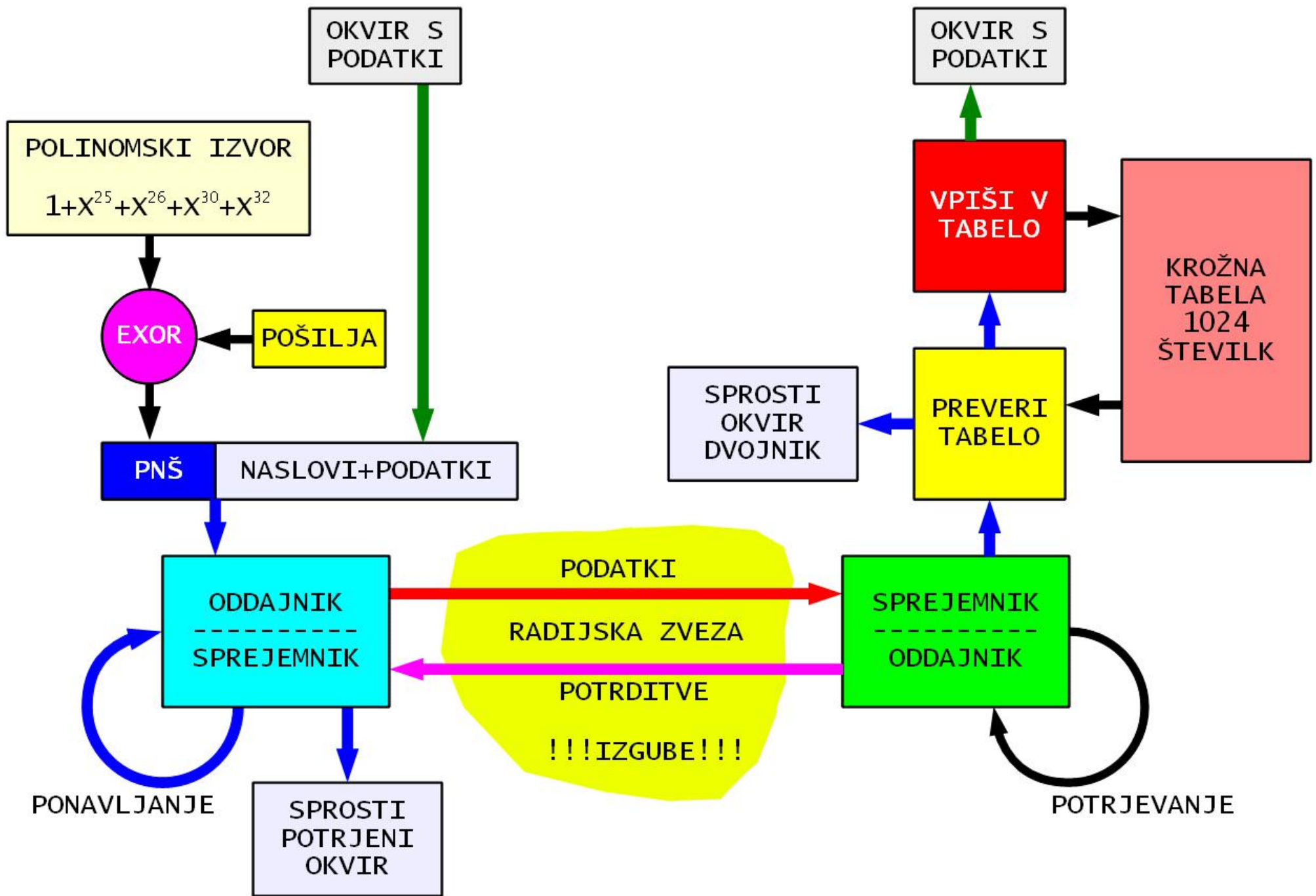

# ZAŠČITA OKVIRJEV NE-BREZHIBNEGA PROTOKOLA



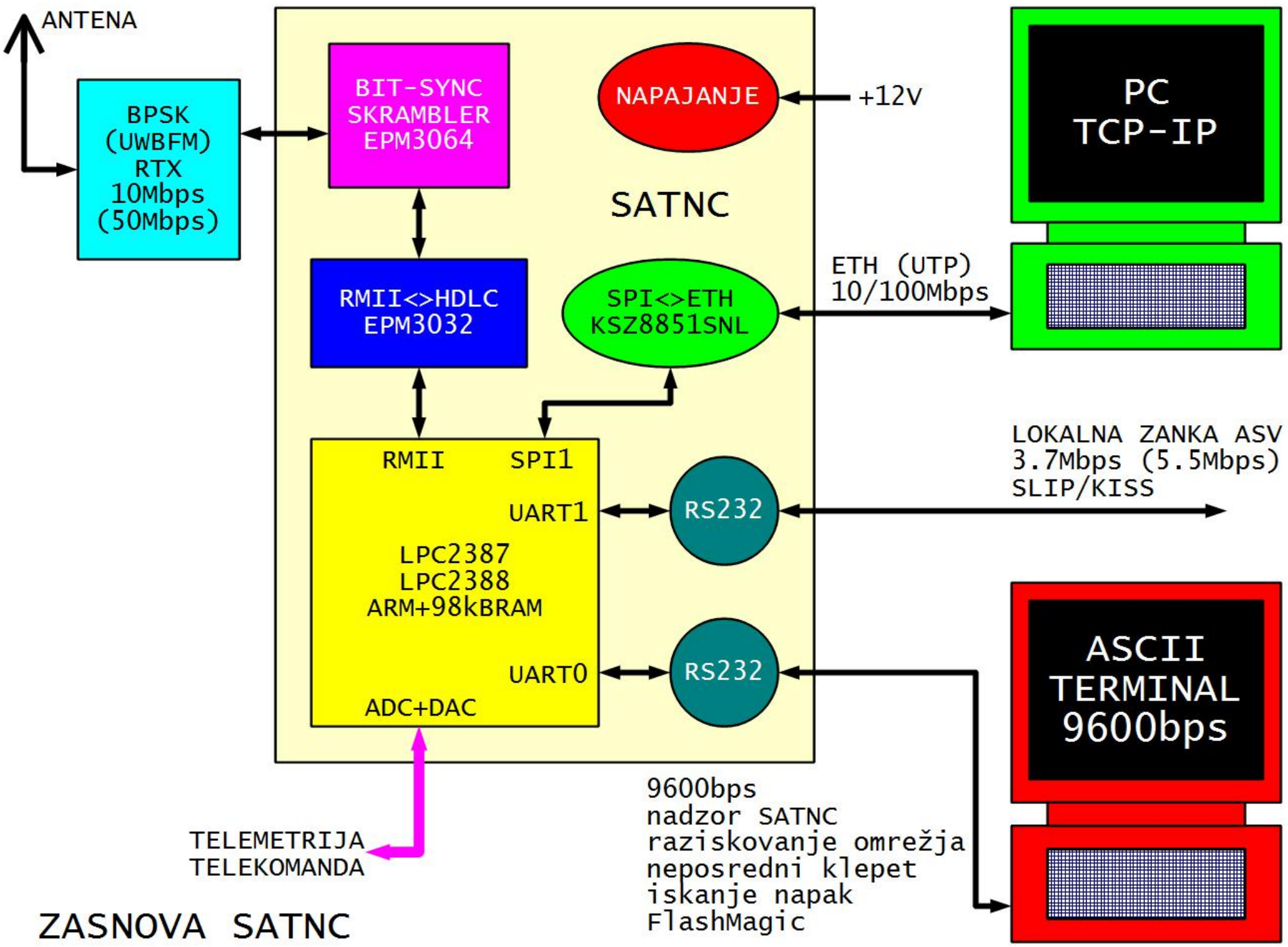

**ZASNOVA SATNC**

Medfrekvenca  
10Mbps BPSK  
(2013)



Radijska glava  
2.3GHz 2W  
domet 100km  
@10Mbps  
(2013)



#6  
±1940MHz

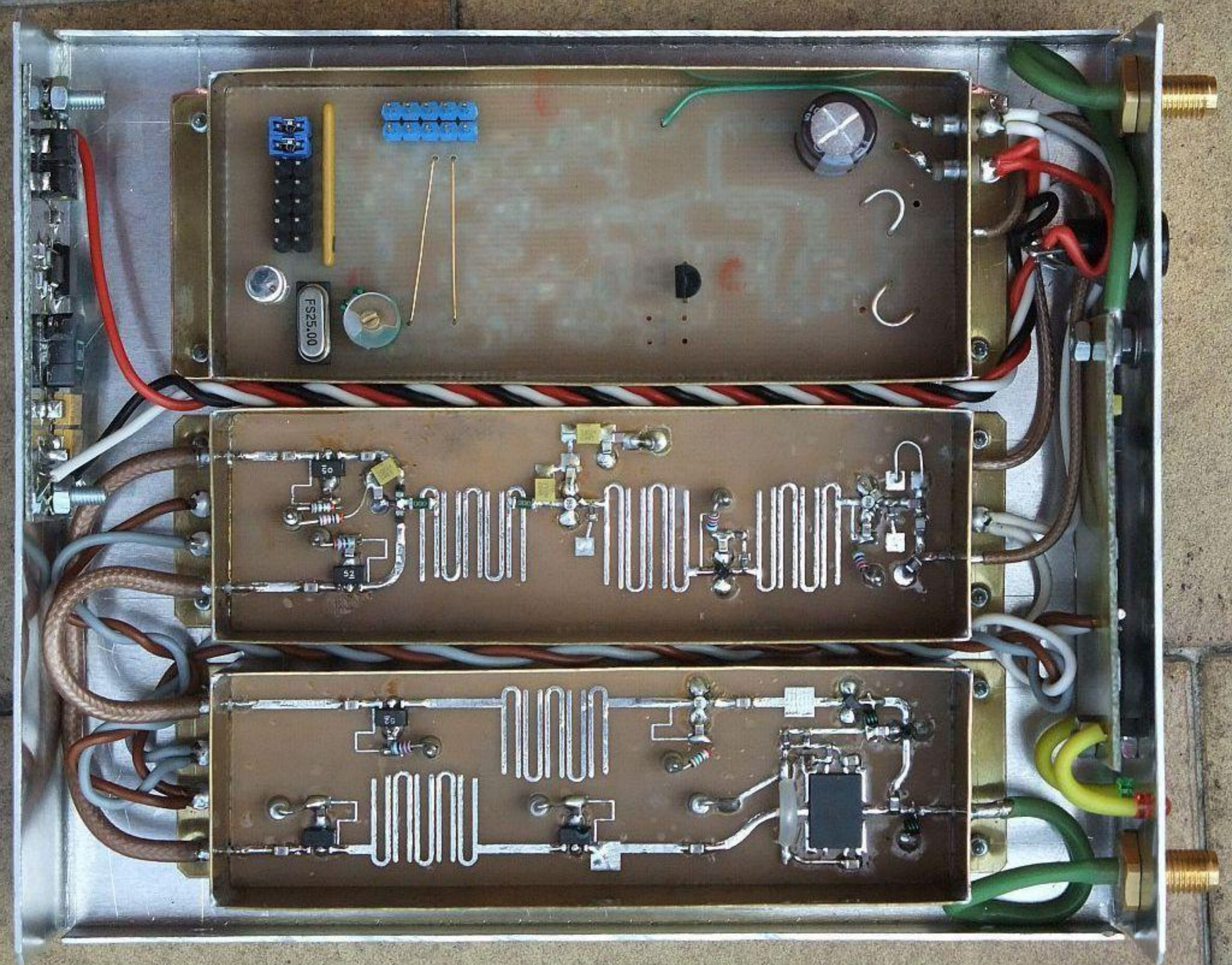

**Radijska glava 3.4GHz 2W 100km @10Mbps (2014)**

# Omrežje NBP 2013-09-10

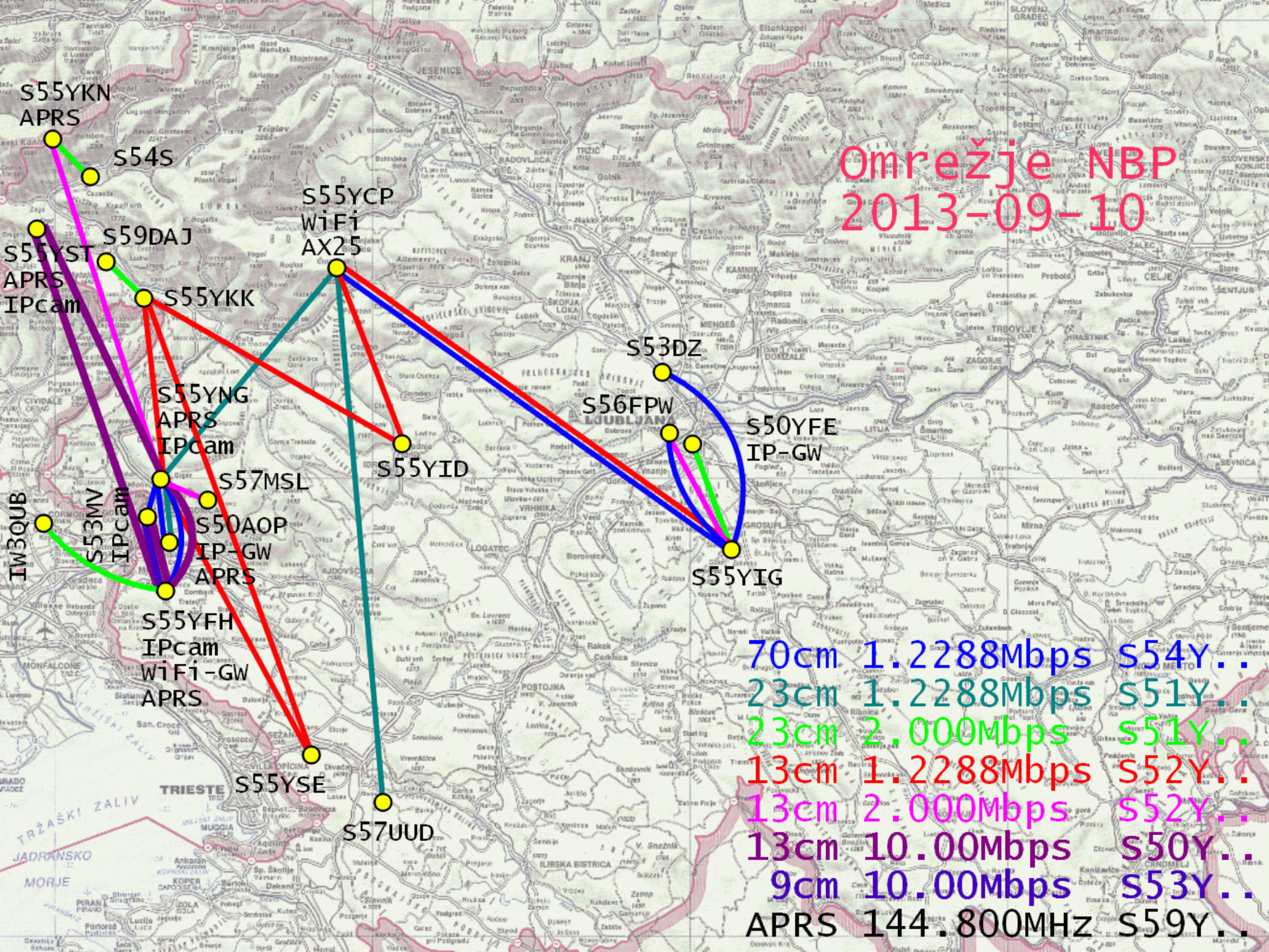

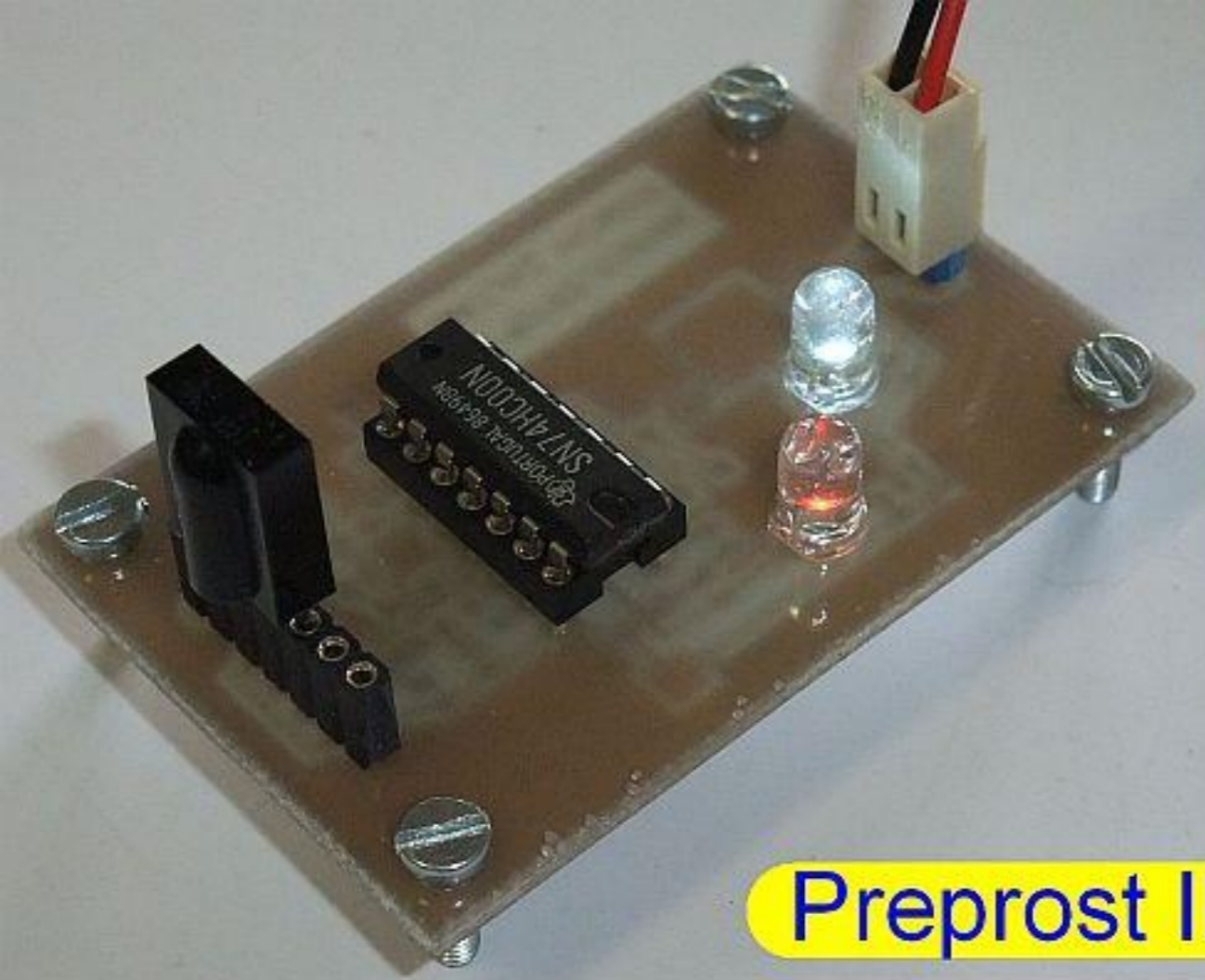

# Preprost IR daljinec

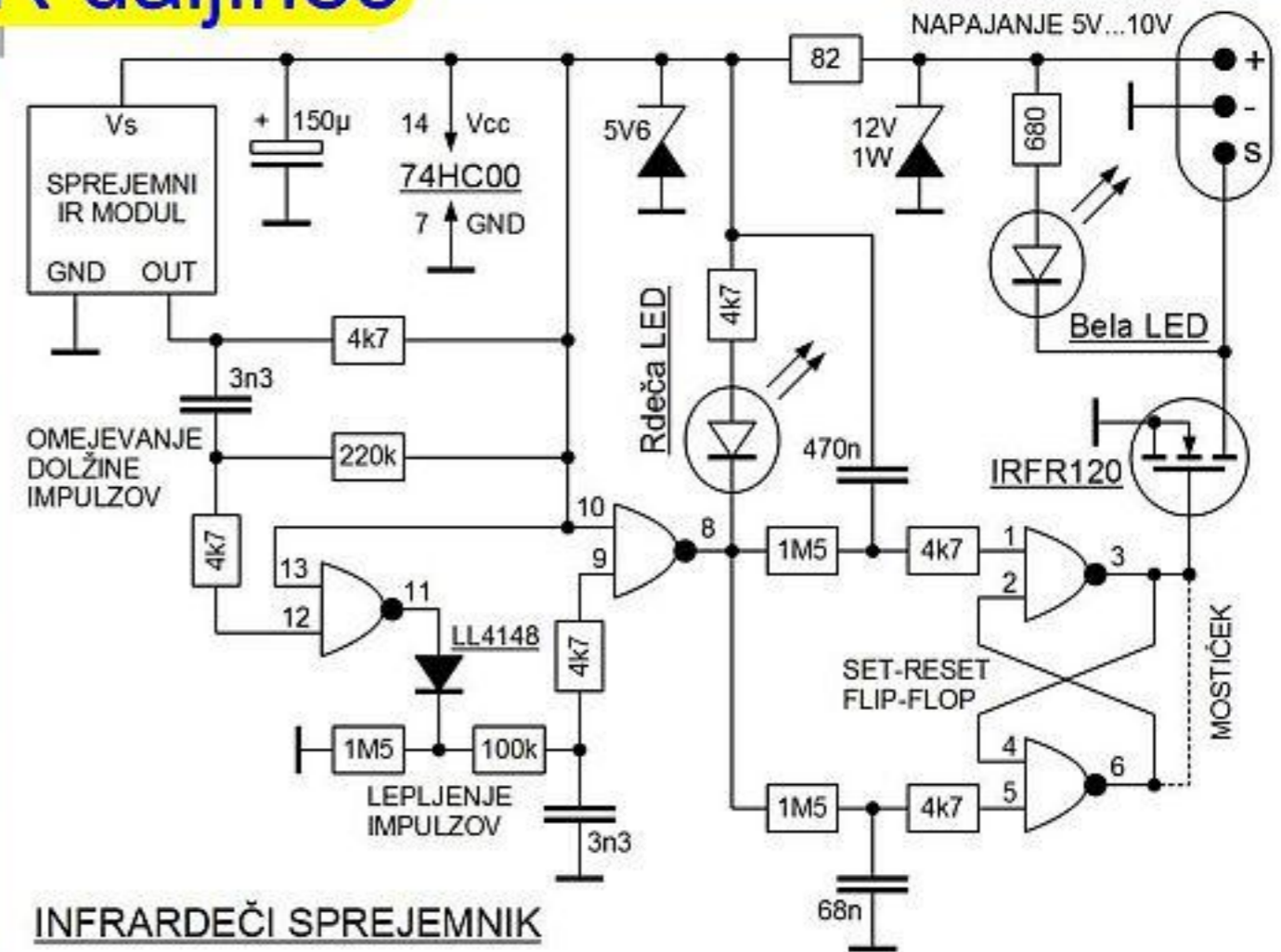
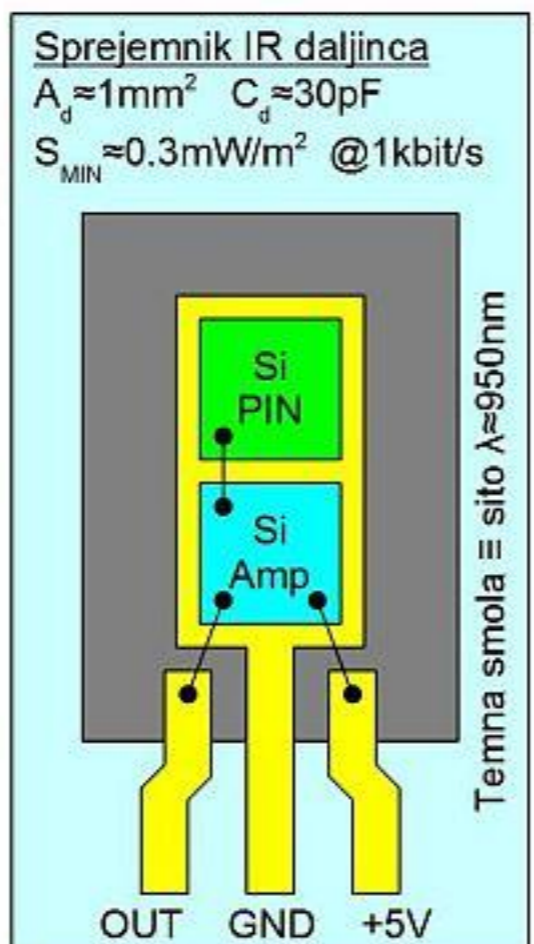
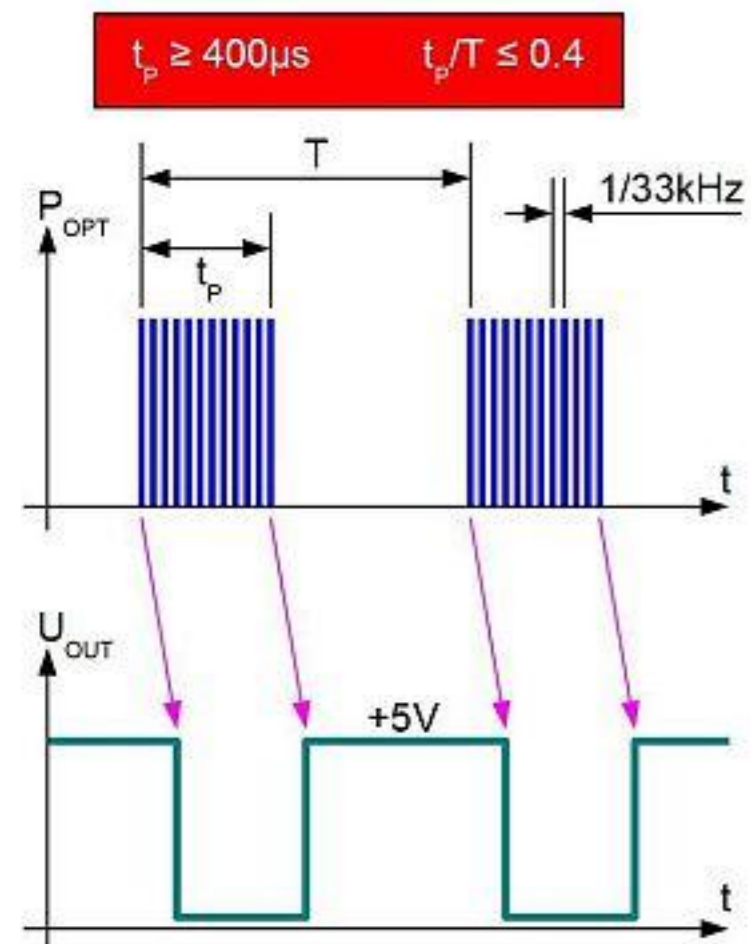



# Študentski UKV FM sprejemnik

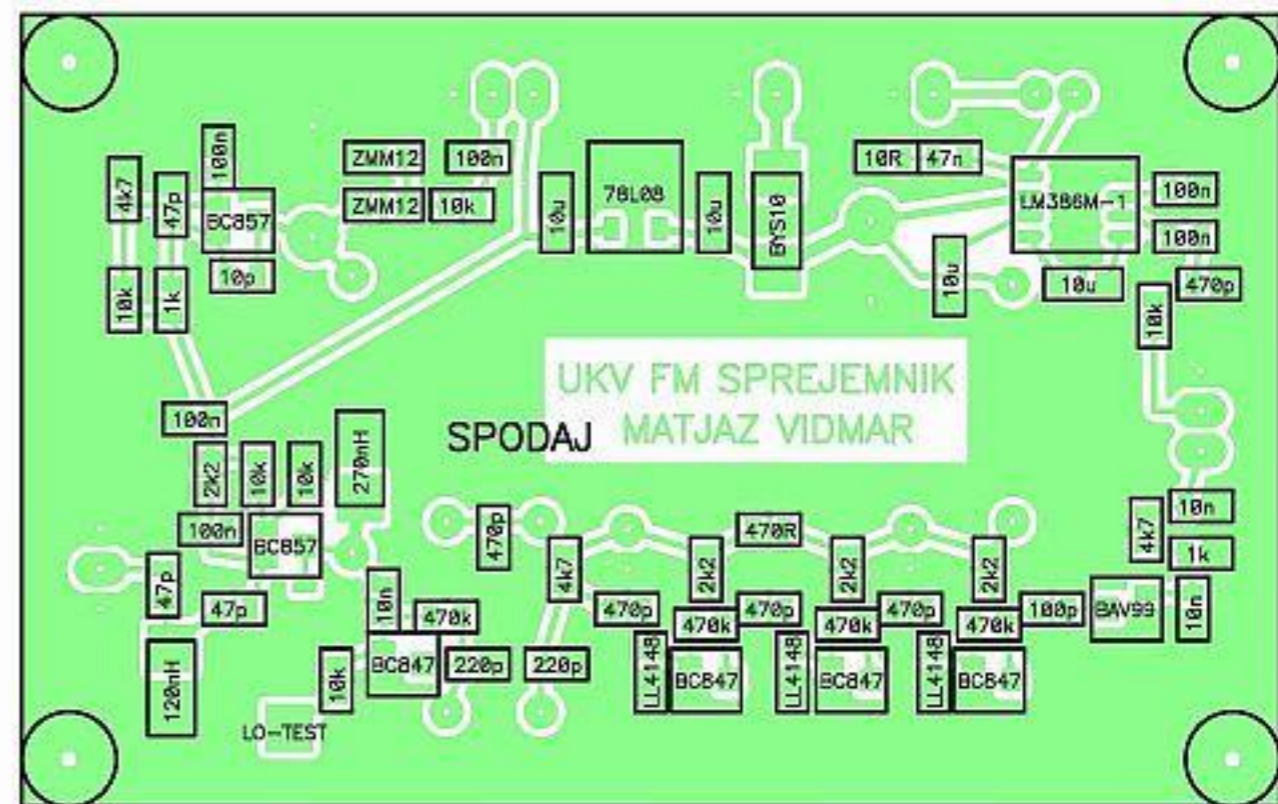

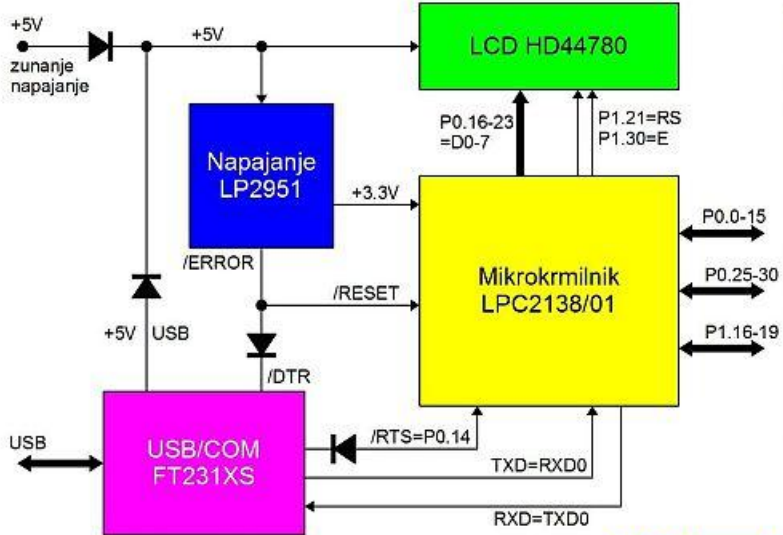

Vezava mikrokrmilnika LPC2138/01

## Mikrokrmilnik

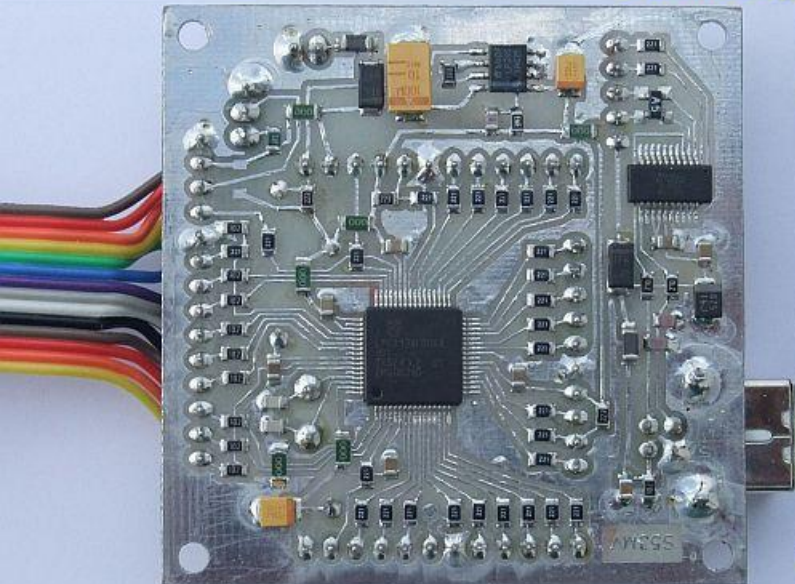

## Frekvencmeter - diploma A. Turšič