

Predavanje z naslovom

**»Pristajalni radarski višinomer za mala letala«**

**redni profesor dr. MATJAŽ VIDMAR, univ.dipl.inž.el.**

ob izvolitvi v naziv redni profesor

četrtek, 23. novembra 2006 ob 12.15 uri v diplomski sobi





UL MOTORGLIDER  
PIPISTREL

SINUS  
UL MOTORGLIDER

S5-PCV

S5-PCV

UL MOTORGLIDER  
PIPISTREL



24.40

33 30

1

1860

10:75

32.7° NAT 00.00  
187.5kmh EG12° 44.33'N  
101.2kt 8#01 +4100' 10  
A 24/09/06 11:24:05

328  
329

**BRÄUNIGER FLUGELECTRONIC S5-PCV ALPHAMFD**

fuel% 00 50 100

temp 70 80

m/s 0 1 2 3 4 5

Km/h 60 70 80 90 100 110 130 150 170 190 210 230 250 270

4094 m 4440 rpm

11:23 CO/Wat.Temp 0:56

▲ ▼ FUNC SET mVt ONH ACM TEMP ENTER MEMO ON OFF

ATTENTION: start and stop giving position only with green proc. position



winter L R

RA GENERATOR ATC

Ajaccio APP  
121.05MHz

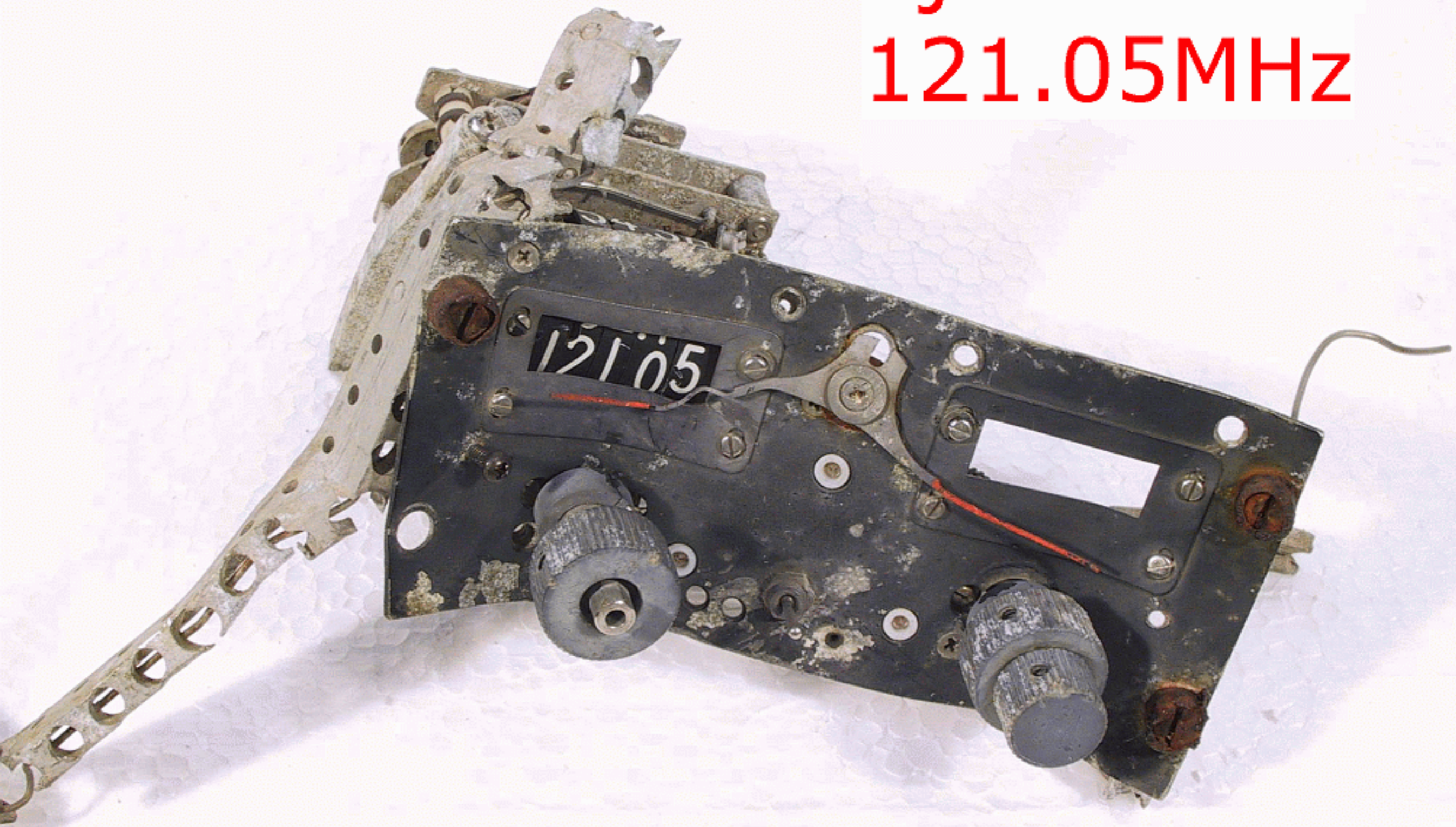

končno približevanje

prekinjajoč ton  
perioda se veča

ravnanje

stalen pisk  
višina tona upada

bip-bip-bip  



biiiiip-biiiiip  



biiiiiiiiiiiiiiii  

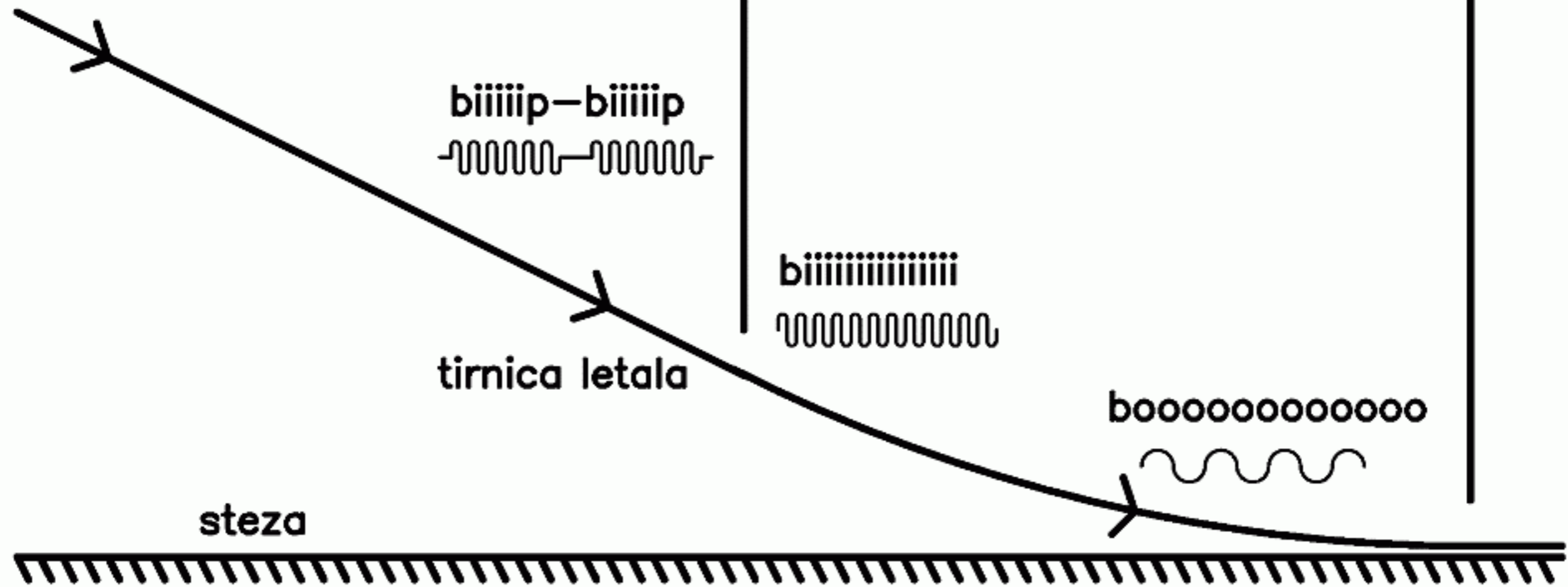

booooooooooooo  

tirnica letala

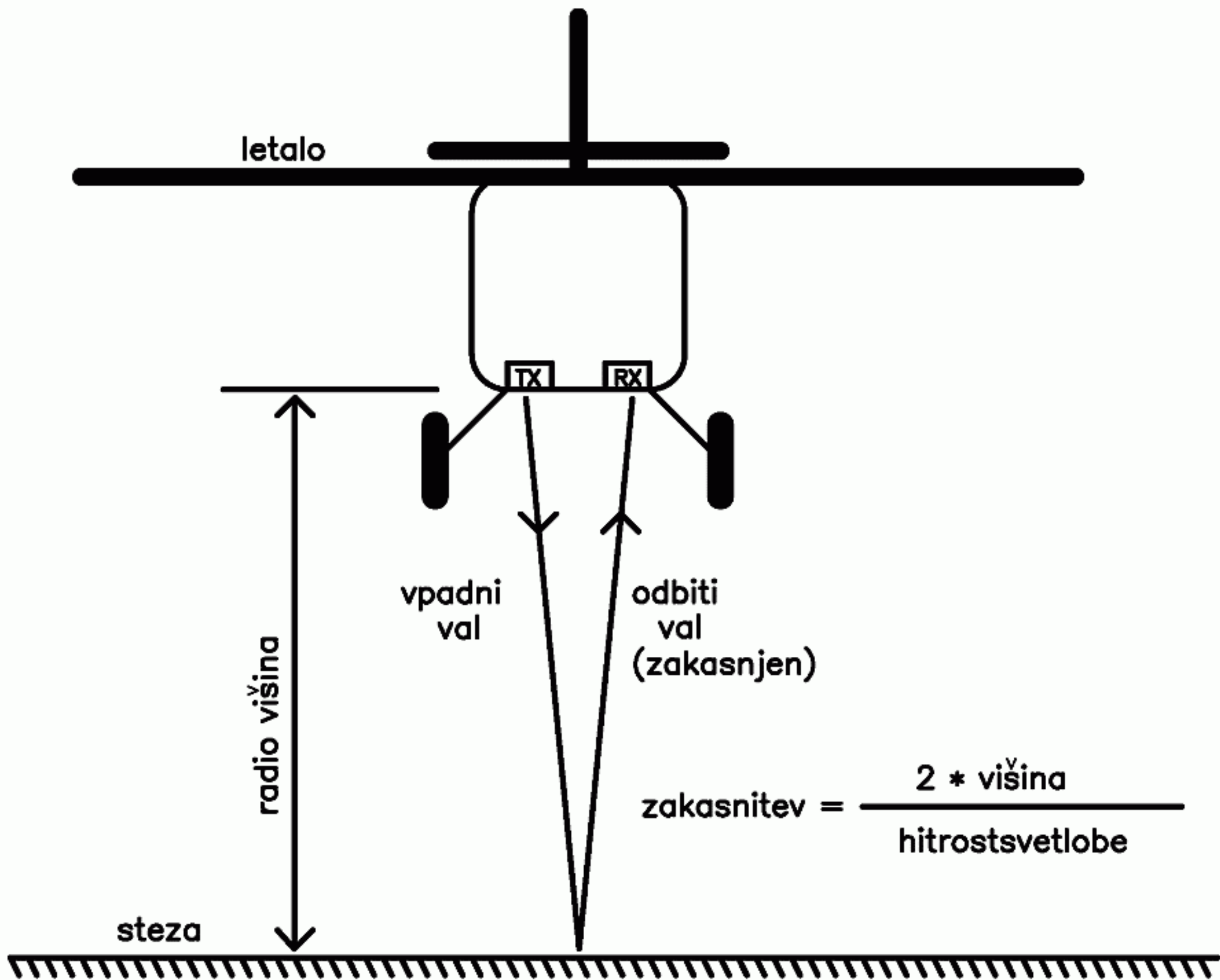
steza



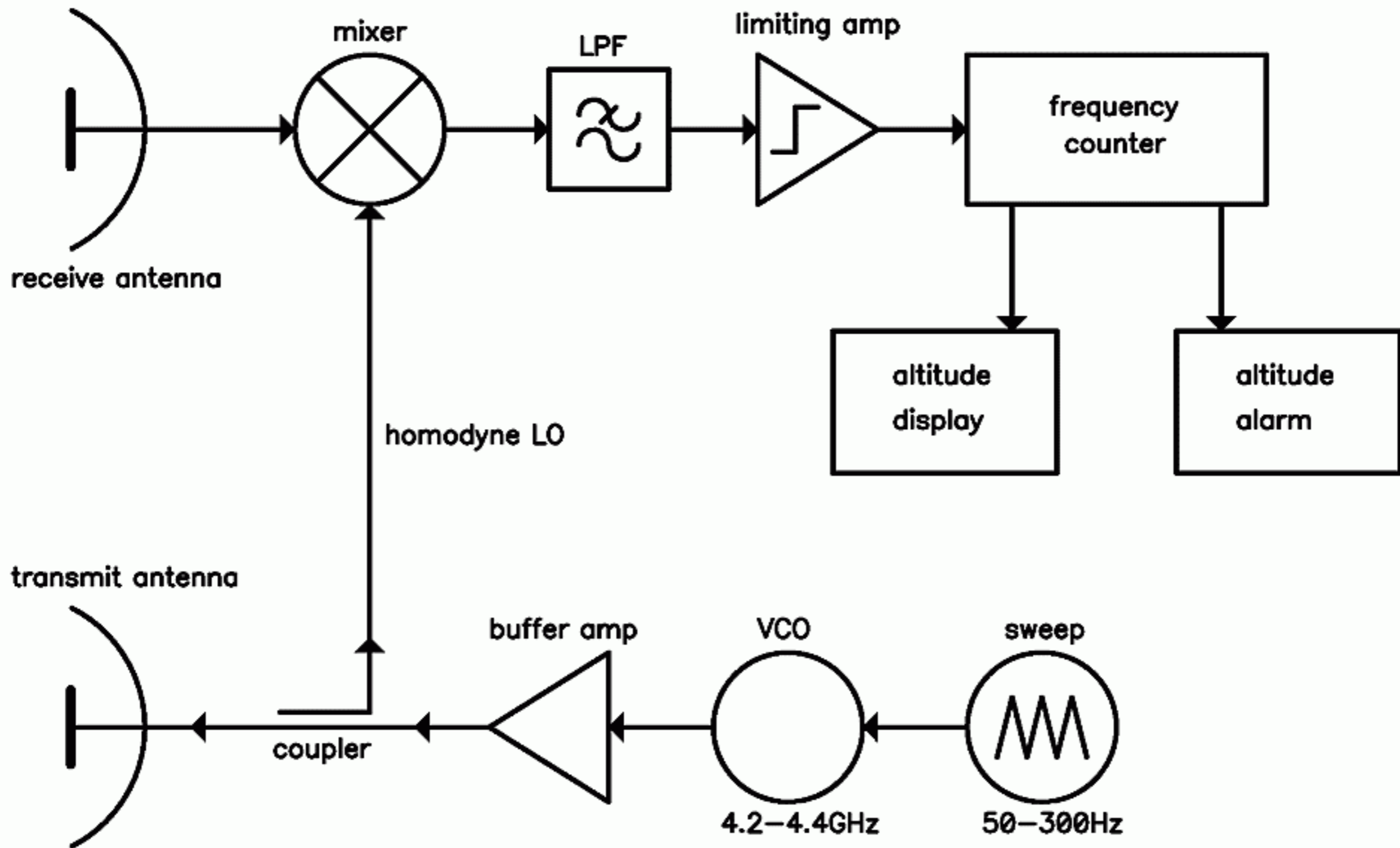





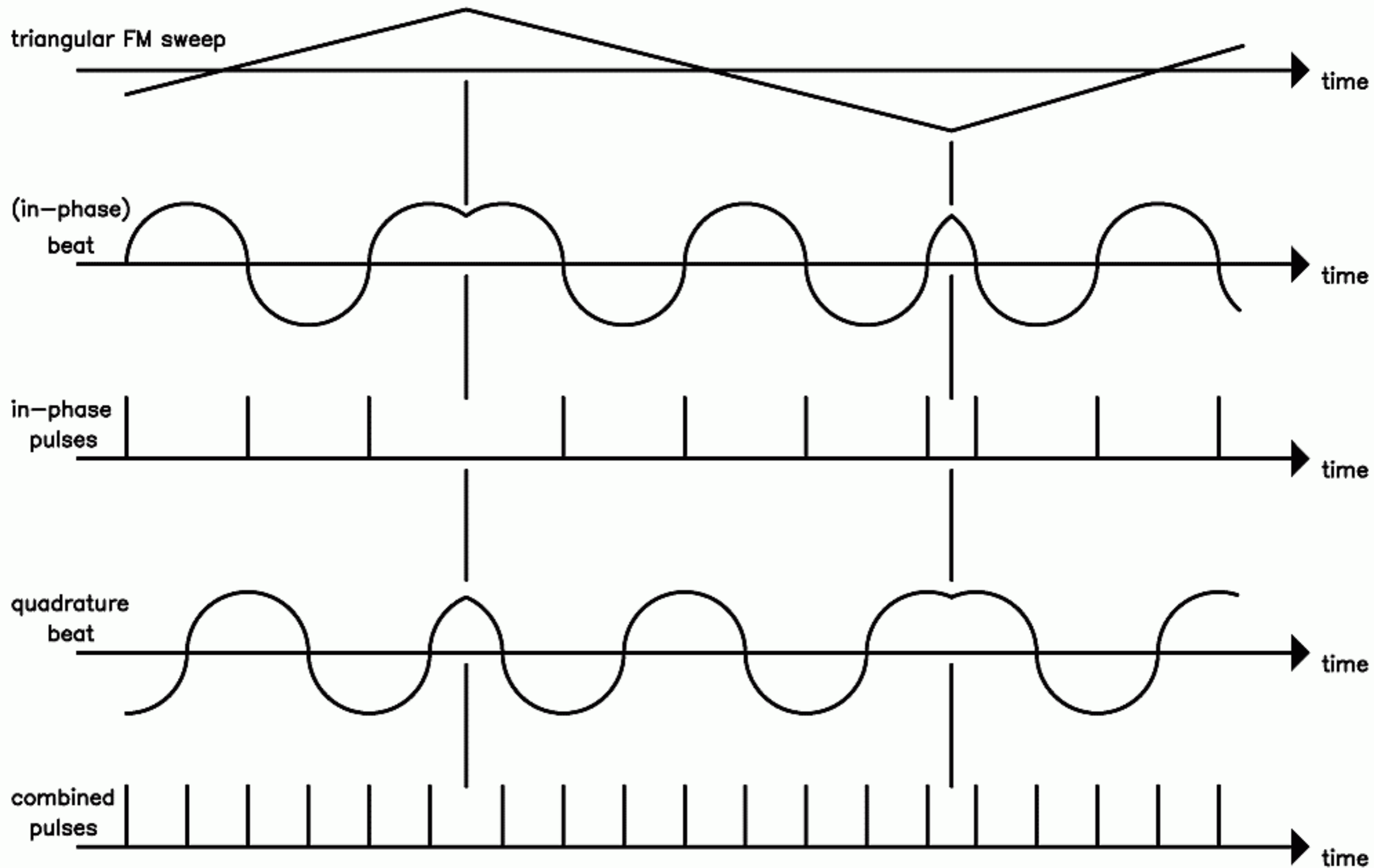

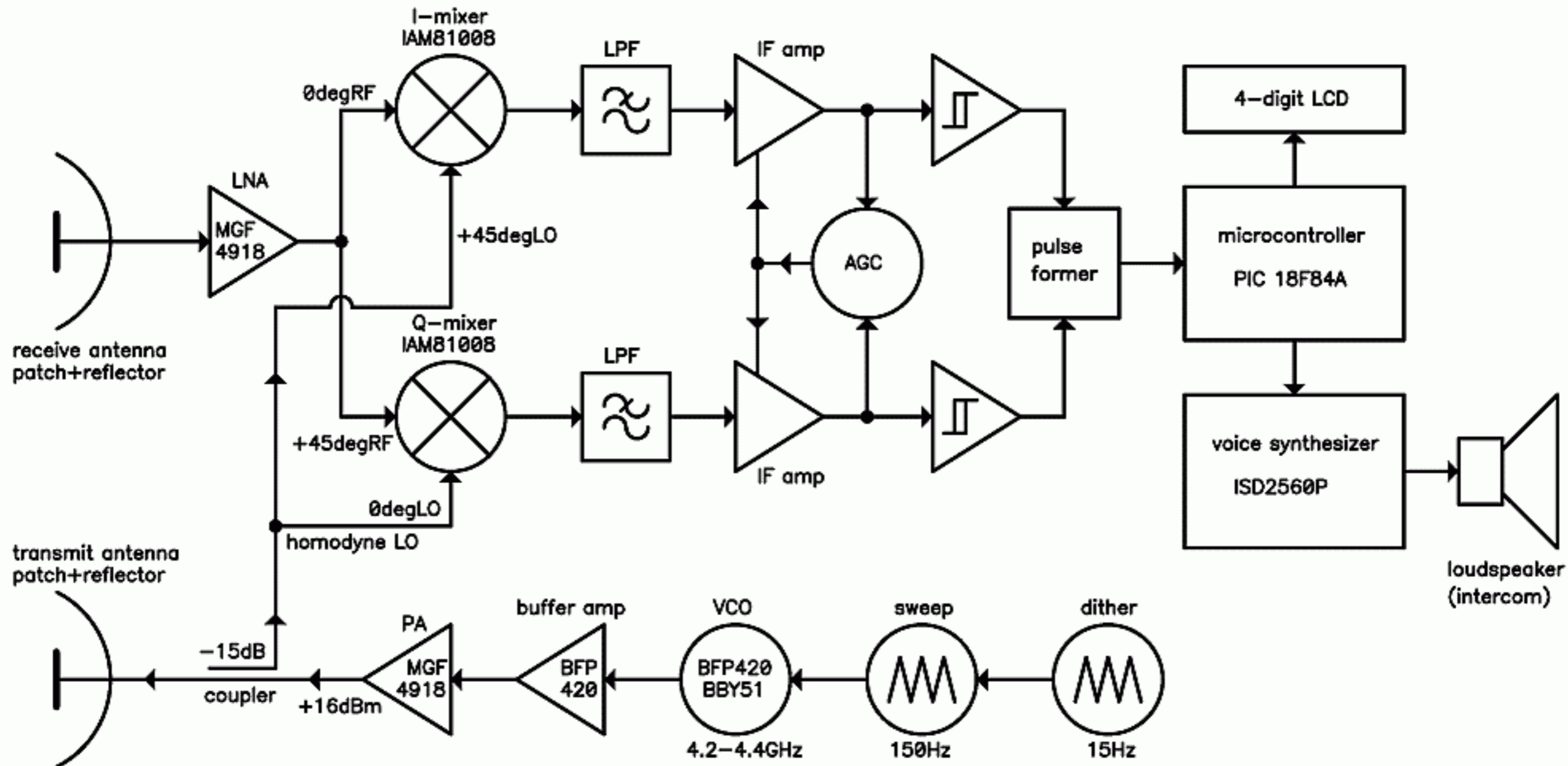



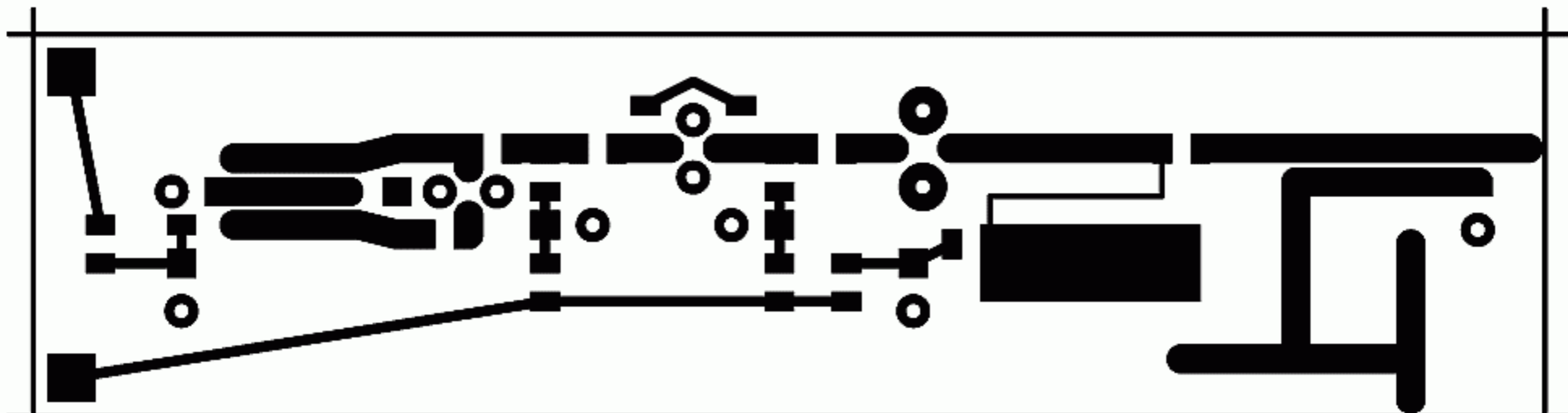

VCO 4.3GHz teflon 19mils  $\epsilon_r=2.43$  80x20

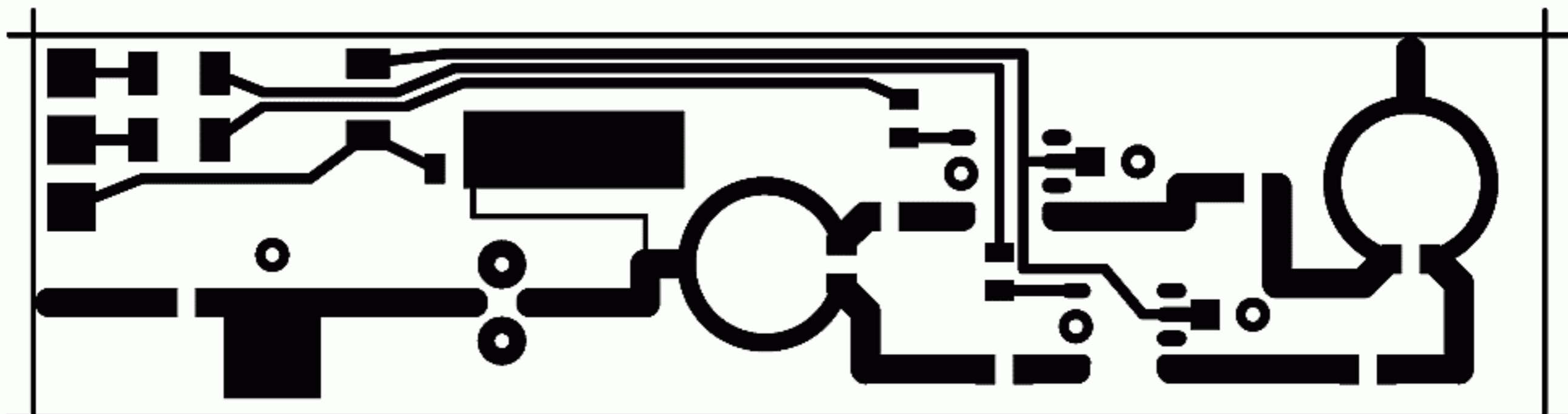

IQmix 4.3GHz teflon 19mils  $\epsilon_r=2.43$  80x20

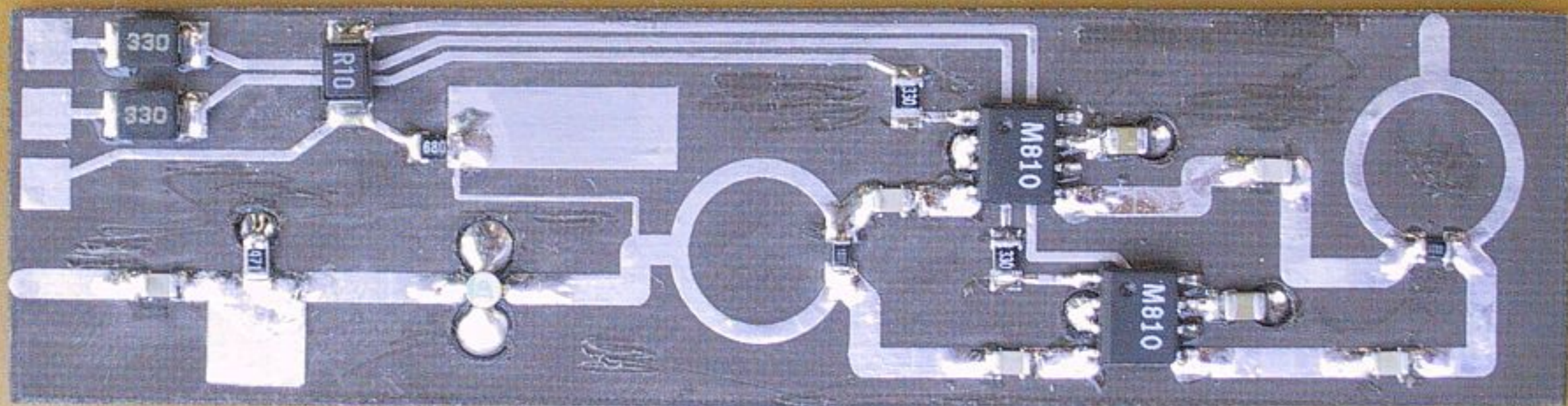
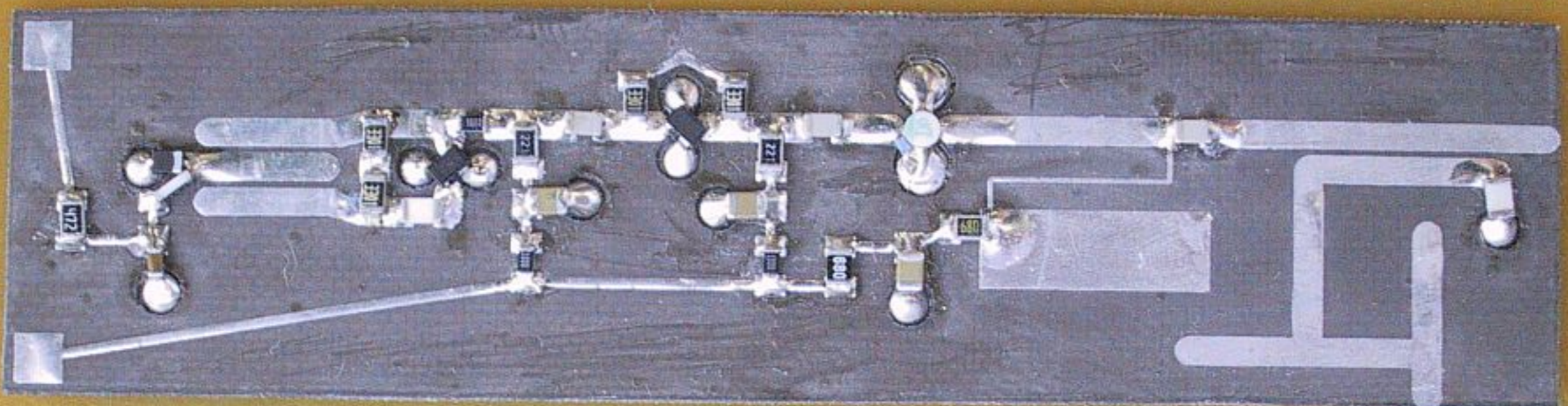

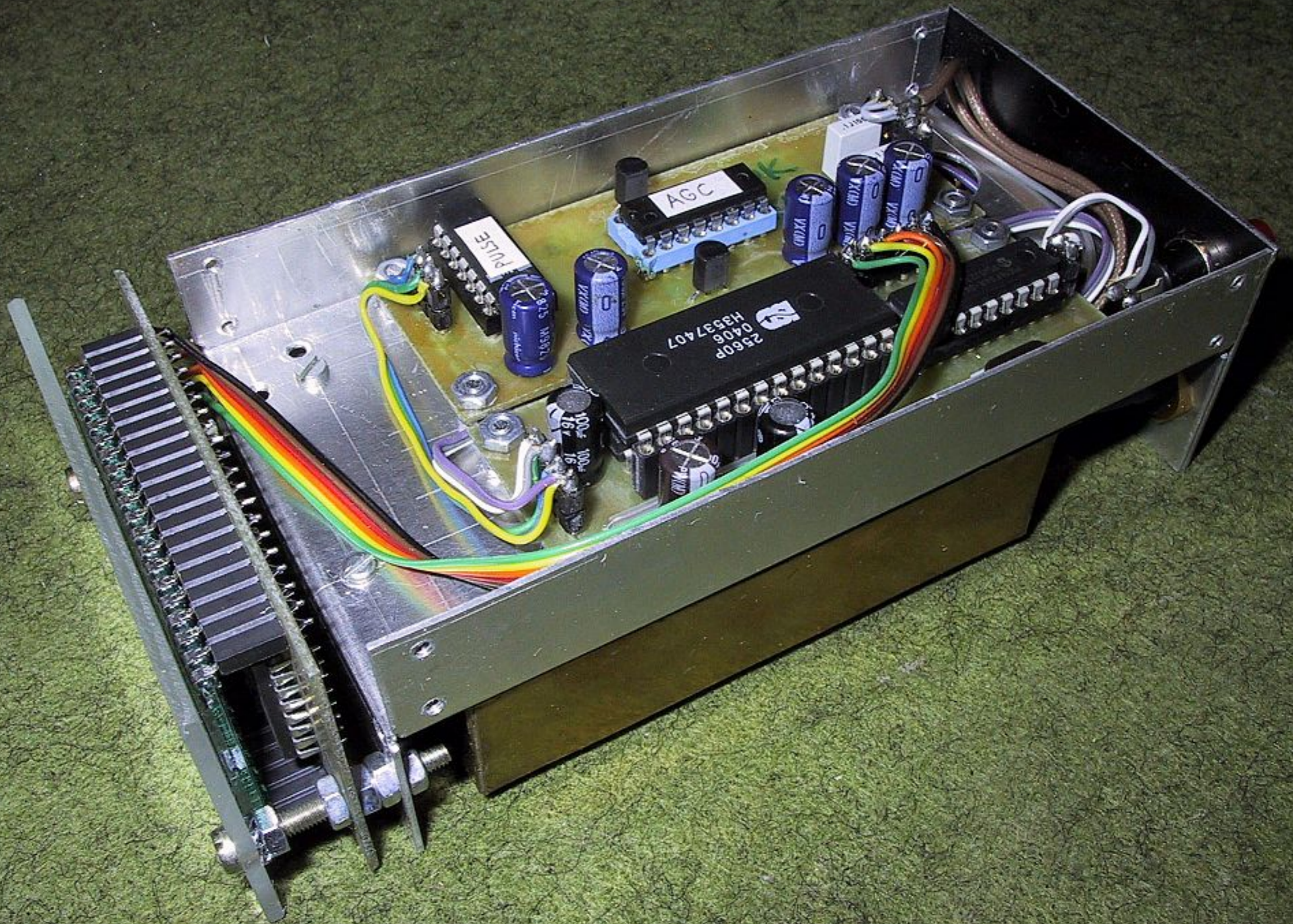









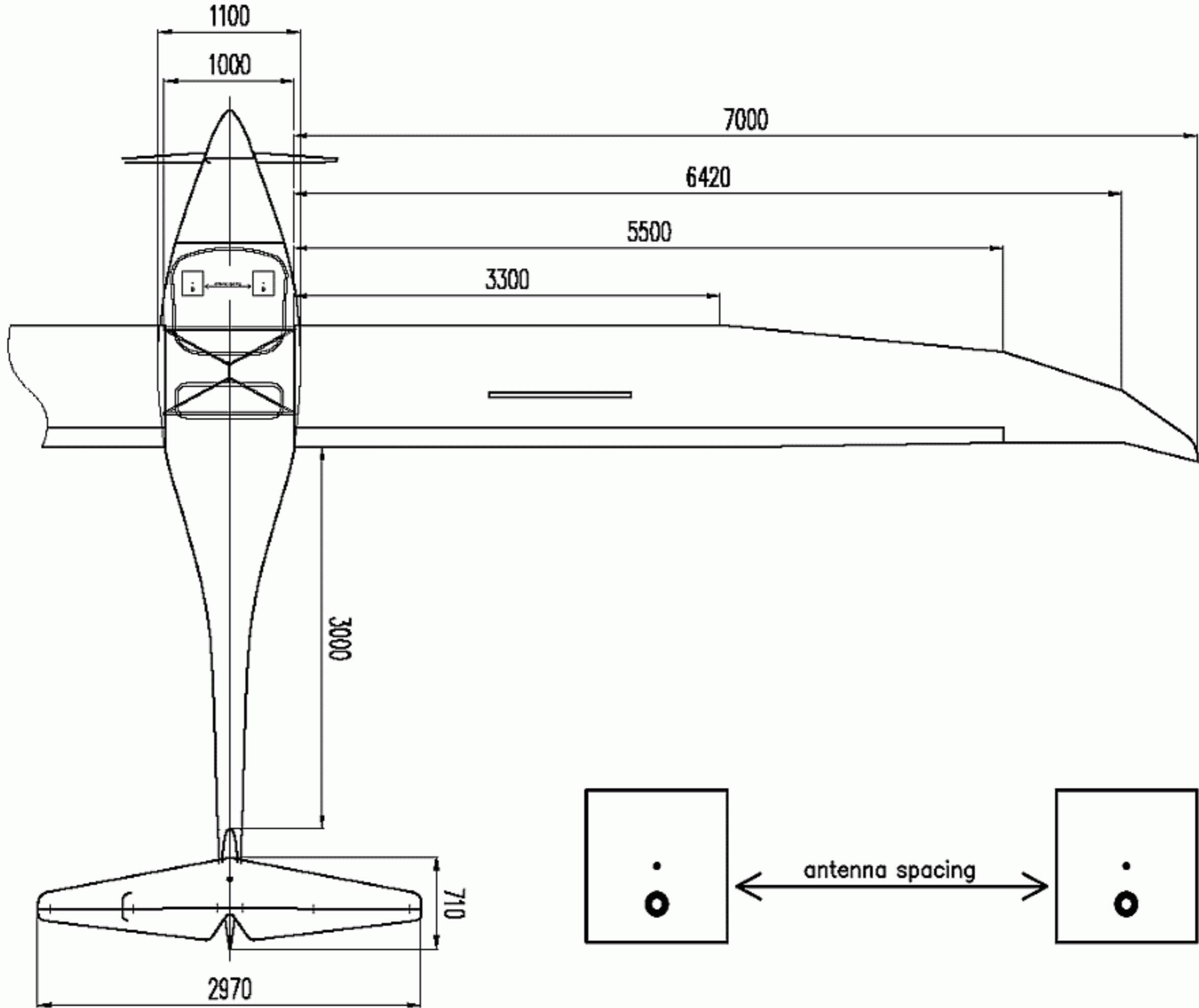

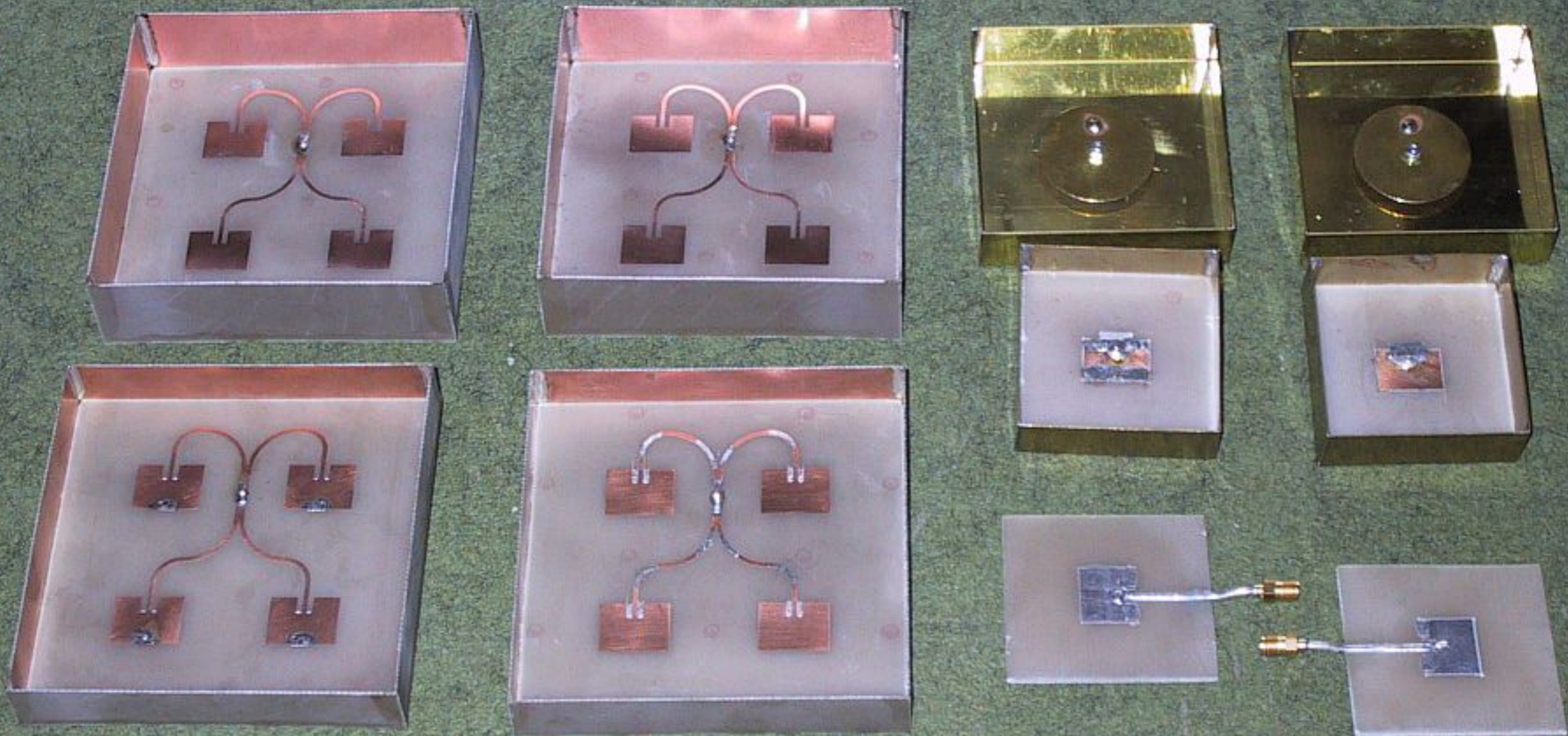



# ADRIA

ADRIA AIRWAYS





Lufthansa Regional

Operated by

CityLine

D-ACLL

3.5 t



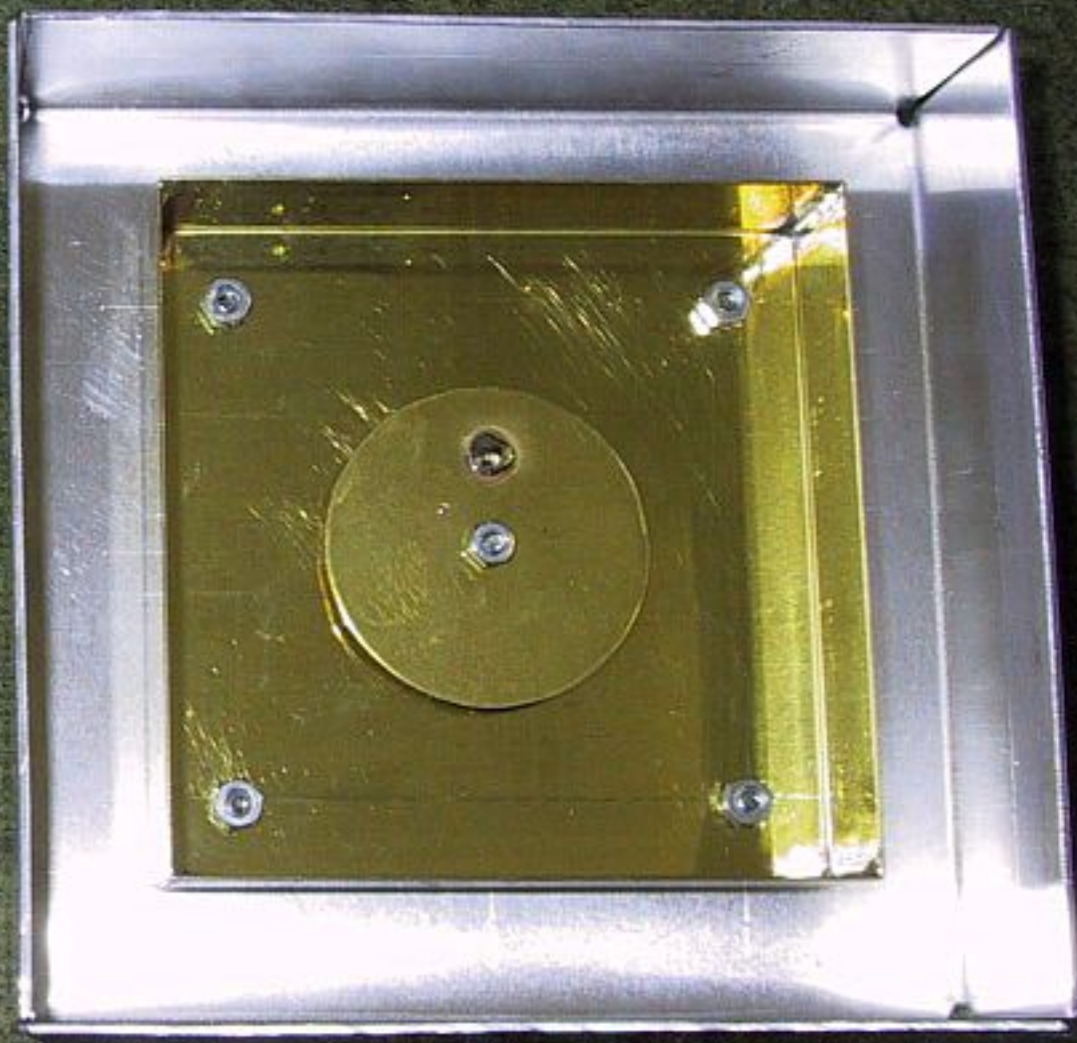
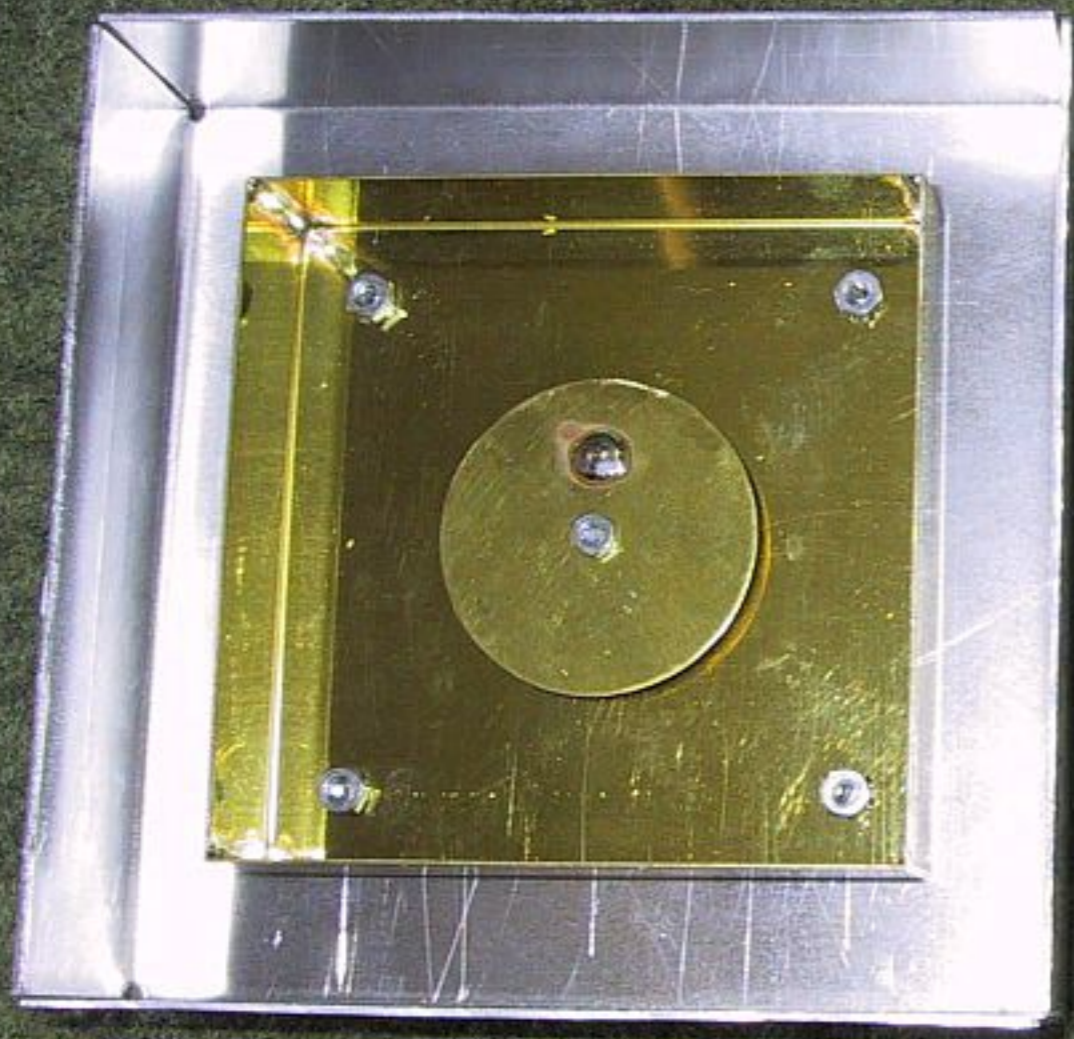





233	VLO (EXT) (L/G EXTENSION)	250
193	VLO (RET) (L/G RETRACTION)	200
	VLE (L/G EXTENDED)	250

A/C 7024  
D-ACLL  
SELCAL CLDR

TAS 0 GS 0 SAT 22C TAT 22C

ONM 00:00  
NM  
NM  
NM

KG  
TCAS OFF  
ABV/BLW  
ALT 014



MAILED

6801089  
STEFANESKI  
1071-157-404  
888/557-404  
WALTON, WA  
AmeriGate  
Kings

R-ALT ANTENNA BLOCKER  
PN: FEMV0001

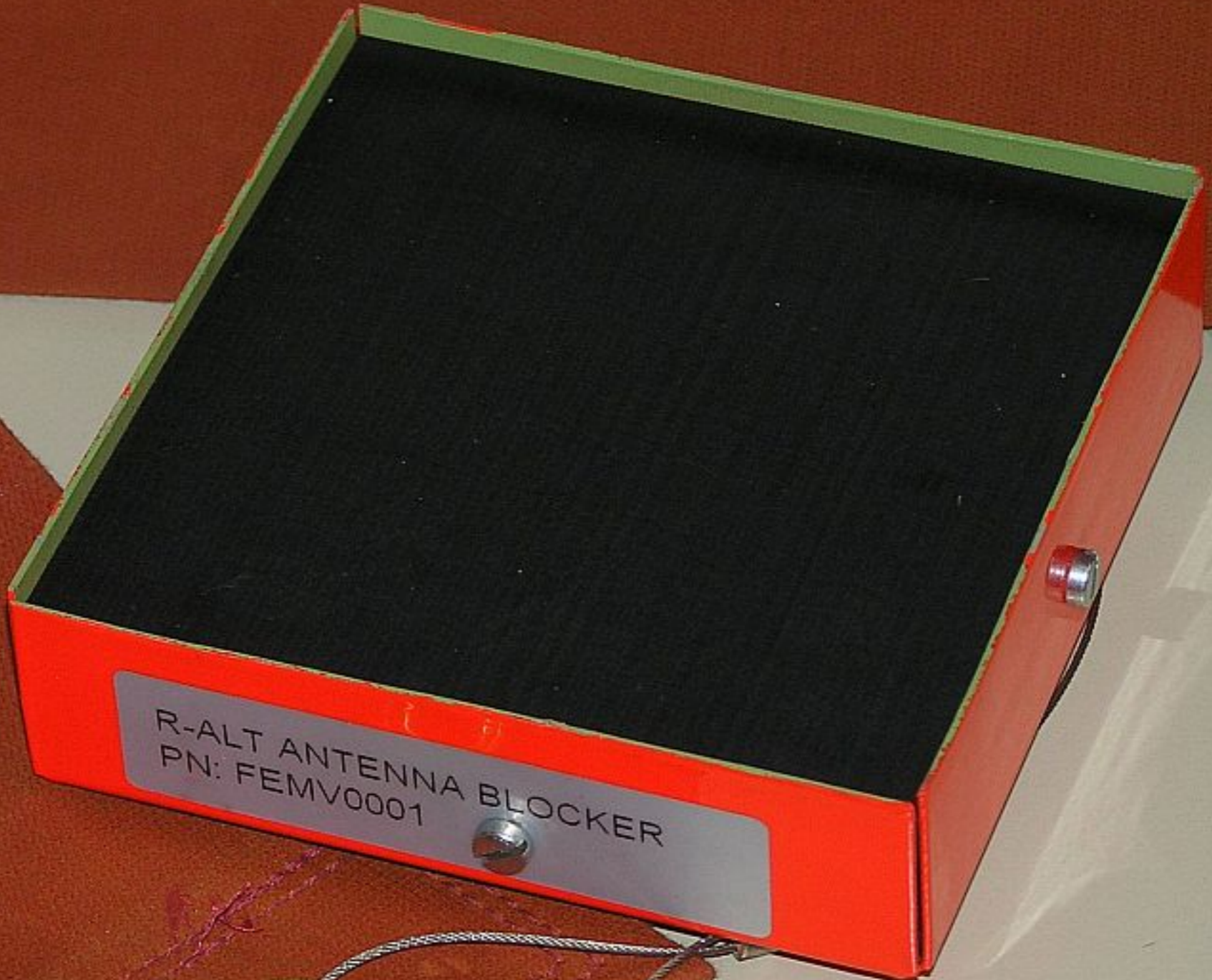



**AIRBORNE NEW AND  
ADVANCED TECHNIQUES OF  
ELECTROMAGNETIC FIELD  
CHARACTERISATION FOR  
AERONAUTICS (ANATEFCA)**

Project Concept proposed for 7th EC Framework Programme

# Potential Near-field (NF-) Scanner Concepts for the Aircraft Sector

**EADS  
ASTRIUM**

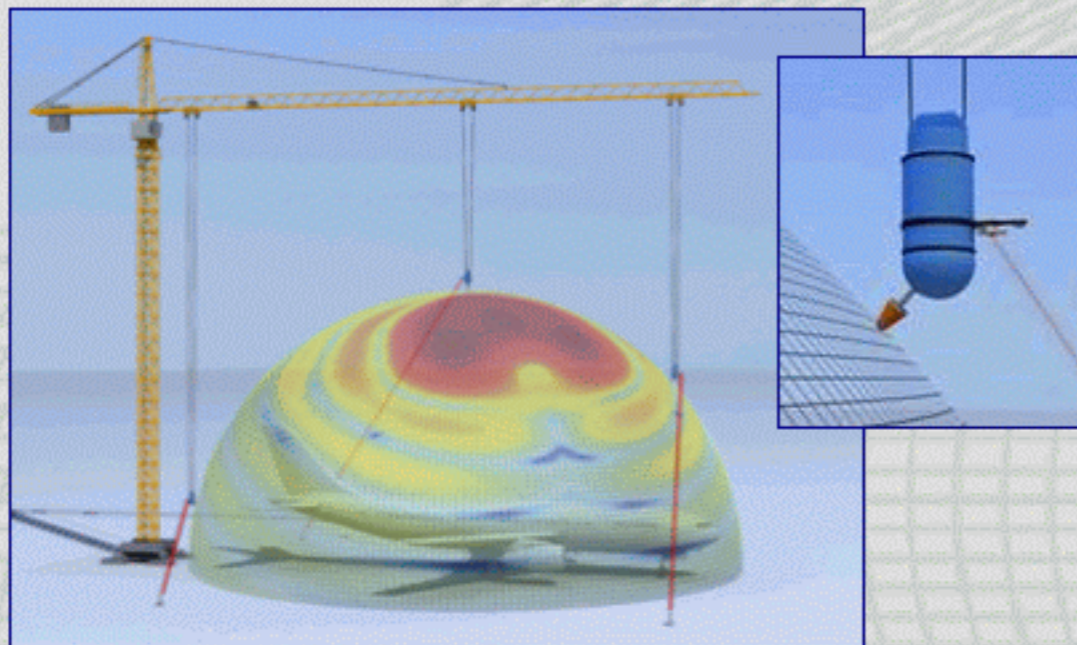

**Crane-Aided Outdoor Scanners for Full or Partial Hemi-Spherical NF-Scans**

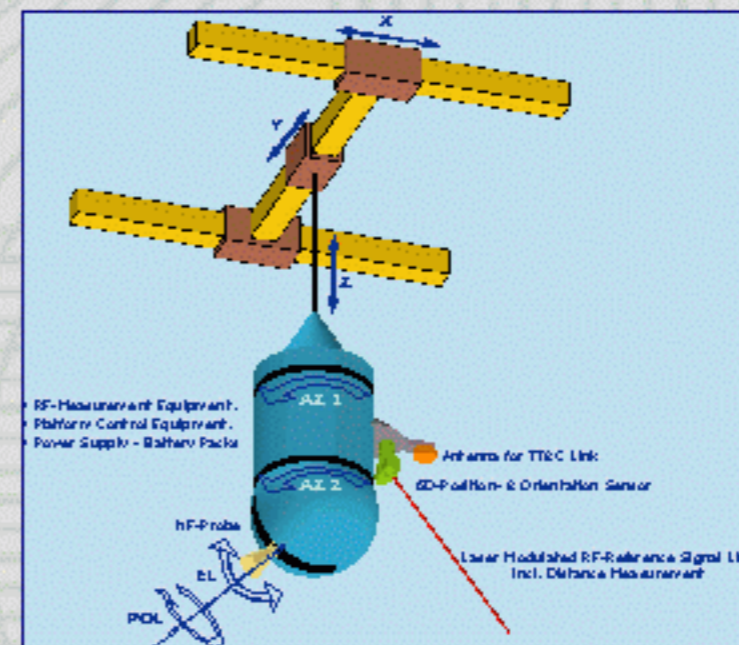

**Crane-Aided Indoor Scanners (e.g. Existing Overhead Cranes in Aircraft Assembly Halls) for Full or Partial Hemi-Spherical NF-Scans**

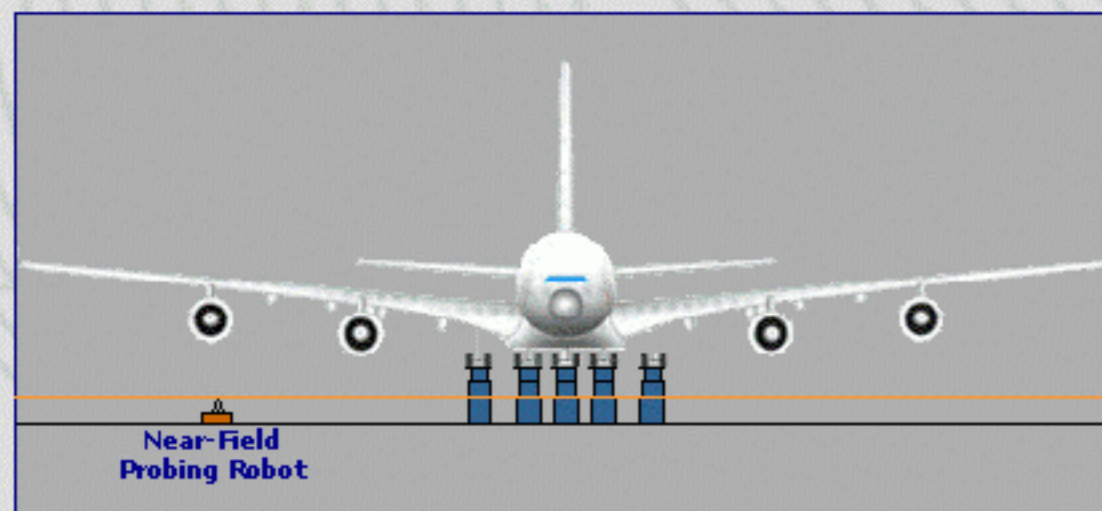

**Ground (Vehicle) Scanners for Horizontal Planar NF-Scans under the Aircraft**

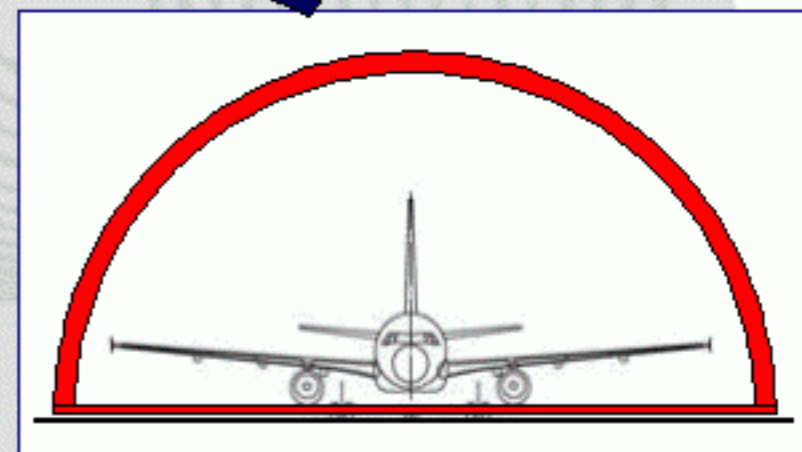

**Near-field Probing on a Closed 3D-Envelope around the entire Aircraft allowing direct Comparison of Simulated Near-field Data in ANY Direction and allowing Transformations into the Far-field for ANY Far-field Cut (360° Coverage @ Infinite Spatial Resolution)**

# Potential Near-field Scanner Concepts for the ATM & Airport Sectors



**Airborne Near-field Scanner System  
for Large Scan Contours  
(Airborne Near-field Test Facility - ANTF)**

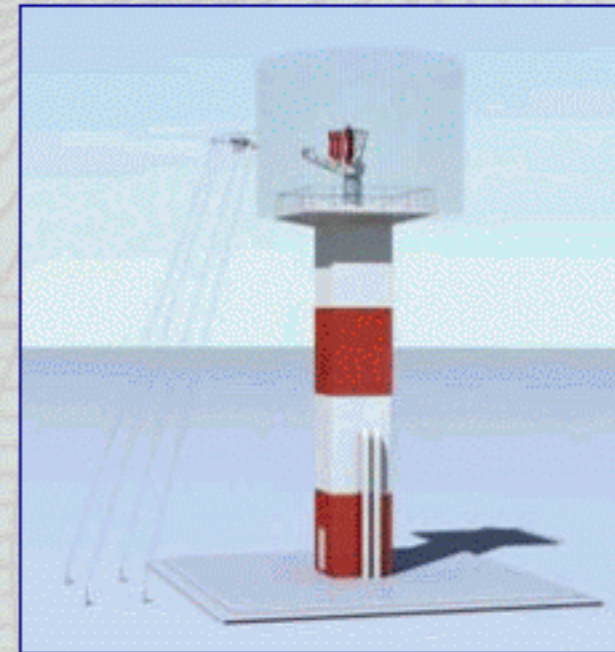

**Characterisation of EM-Fields of  
Radar Surveillance Installations  
(e.g. Primary & Secondary Radar Antennas)**

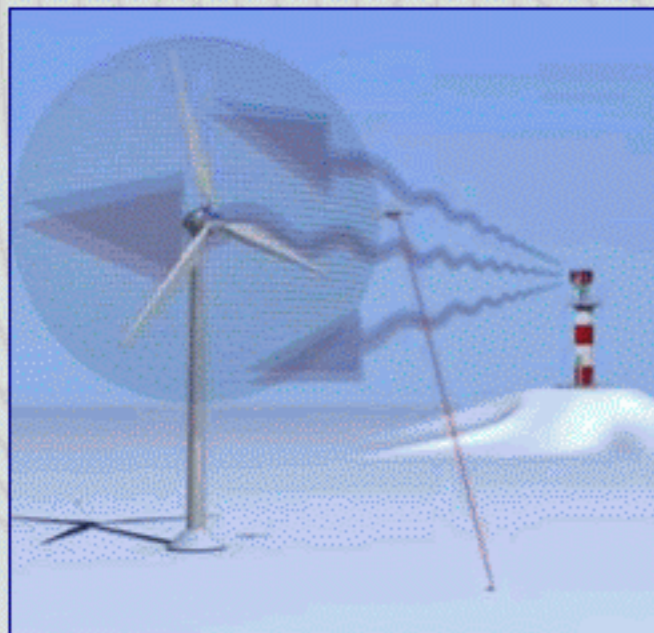

**Characterisation of Scattering Objects  
(e.g. Wind Generators)**

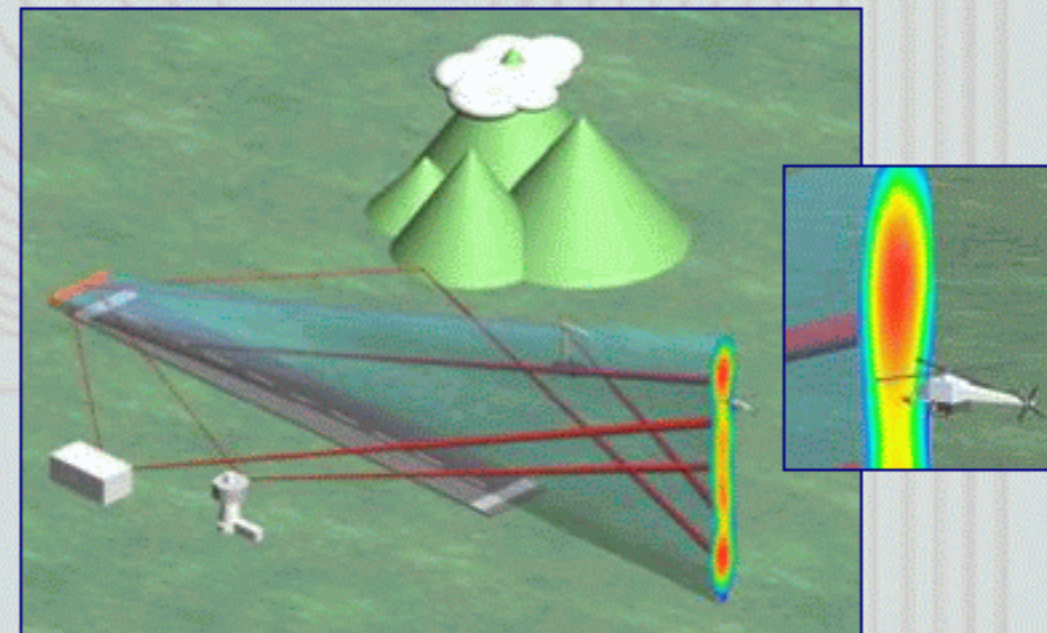

**Characterisation of EM-Fields of  
Installed Navigation Aid Installations (e.g. ILS)**



## Potential Consortium Partners of ANATEFCA

1. EADS Astrium (Industry - D) ✓
2. EADS CCR Toulouse (Industry - F) ✓
3. NLR (Research Institute - NL) ✓
4. Flight Calibration Services (SME Aero. - D) ✓
5. PTB (Public Authority for Standards- D) ✓
6. DGAC (Public Authority Aero. - F) ?
7. EUROCONTROL (Public Authority Aero. - BE) ?
8. Fraunhofer IIS (Research Institute- D) ✓
9. AlpinaTec (SME - A) ✓
10. EMV-Consulting (SME - A) ✓
11. AcQ Inducom (SME - NL) ✓
12. University of Stuttgart (D) ✓
13. University of Ljubljana (SLO) ?
14. University of Calabria (I) ✓
15. TU Delft (NL) ✓
16. FH Wels (A) ✓

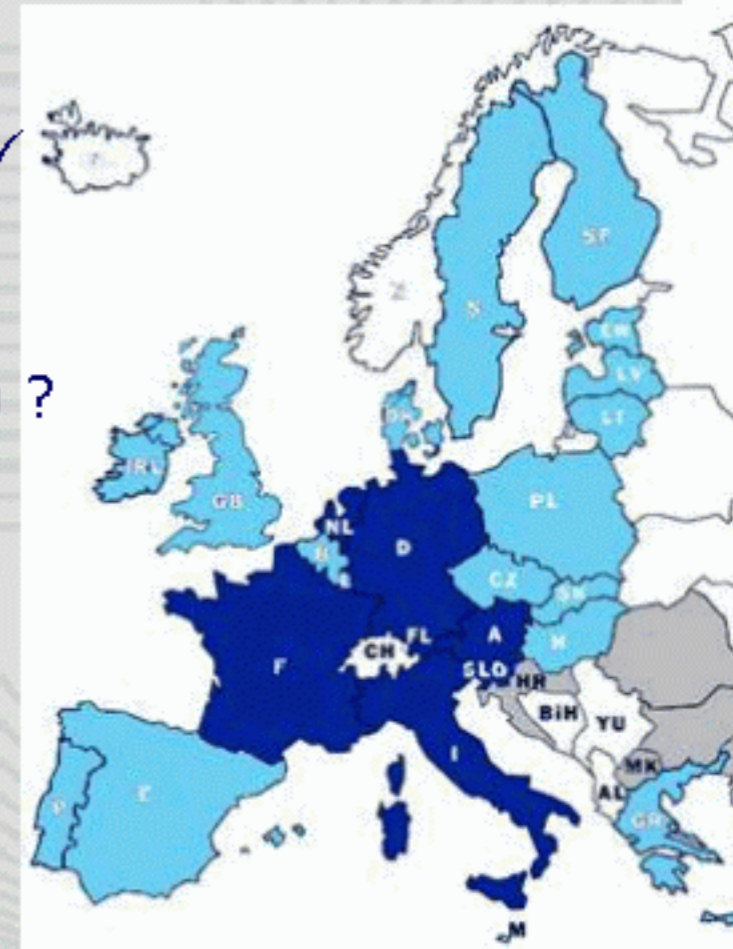

European Countries  
addressed by ANATEFCA



Subject: Spaceship 2 radio altimeter  
Date: Tue, 7 Nov 2006 14:13:41 -0800  
From: "Shawn Keller" <shawn.keller@scaled.com>  
To: <s53mv@uni-mb.si>

Dear Mr. Uidmar,

I ran across your website, and was very impressed with your technical expertise. Very impressive set of instrumentation. I particularly like the fact that you prefer PIC microcontrollers, as that is my favorite type to implement in my own designs.

I don't know if you are familiar with SpaceShipOne, the first manned commercial spacecraft that my company built and flew in 2004. See [www.scaled.com](http://www.scaled.com). It made three sub-orbital trips to space to win the X-prize and afterwards was retired to the National Air and Space museum in Washington, DC, USA. I am the electronics engineer for Scaled and have designed most of the electrical systems for Scaled for the past 12 years.

We are now in development of SpaceShipTwo (SS2), the commercial follow on to SS1, and we are calling out a radio altimeter to be installed to assist with the landings. I was wondering how you would feel about duplicating your radio altimeter design for us, particularly the RF sections, with a few small modifications. The first SS2 will strictly be a prototype and remain in the experimental category. It is likely we would use a commercial unit for the follow on vehicles.

What do you think, interested?

Sincerely,

Shawn Keller  
Electronics Engineer  
Scaled Composites, LLC.  
1624 Flight Line  
Mojave, CA 93501  
(661) 824-6328







PHOTOS FROM VIDEO



PHOTO COURTESY OF SCALED COMPOSITES, LLC



PHOTO COURTESY OF SCALED COMPOSITES, LLC



099:15:11:30.281



PHOTOS FROM VIDEO



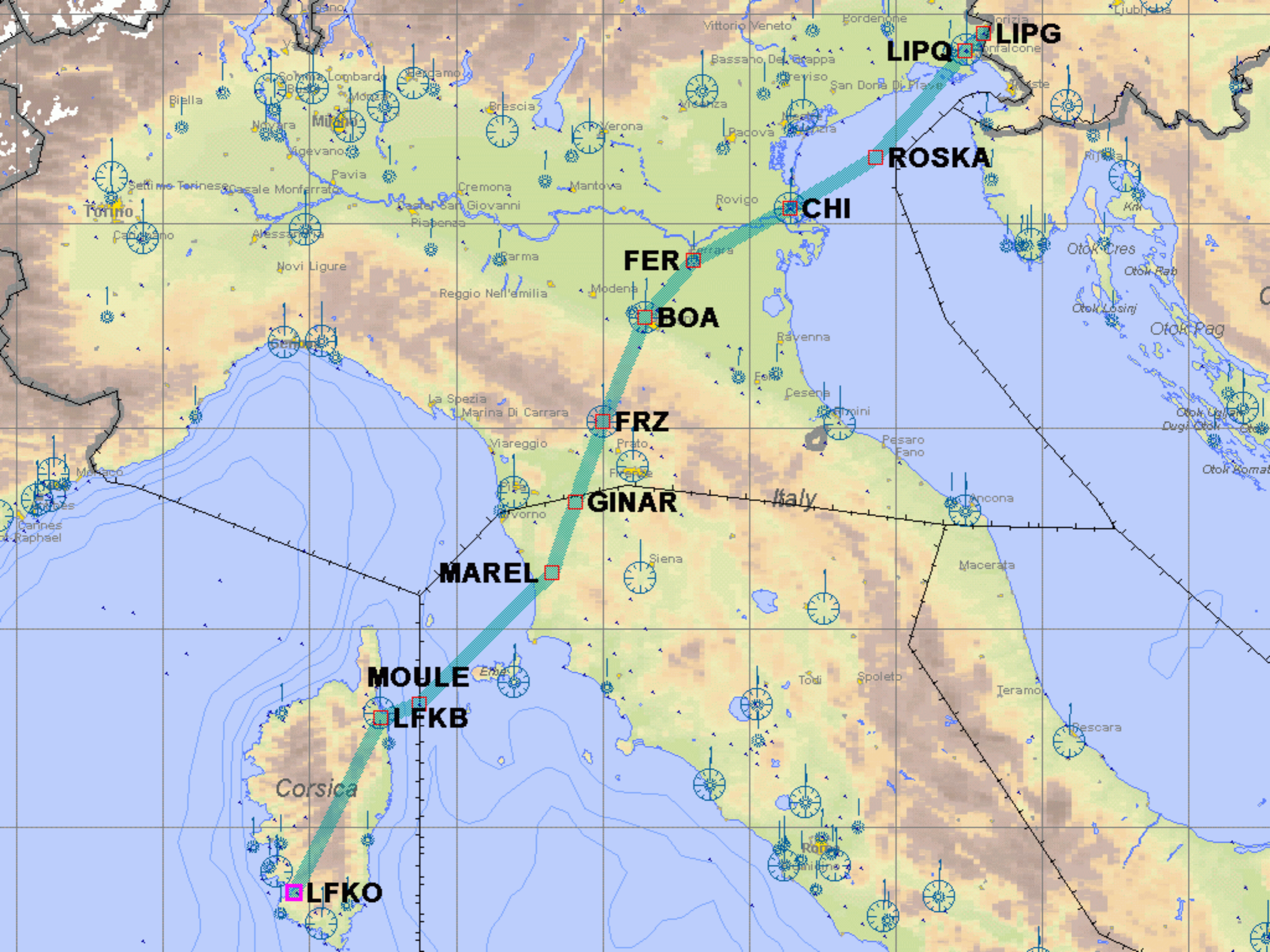

**LIPQ** **LIPG**

**ROSKA**

**CHI**

**FER**

**BOA**

**FRZ**

**GINAR**

**MAREL**

**MOULE**

**LFKB**

*Corsica*

**LFKO**

*Italy*

