

Ultra High-Speed and Ultra Low-Noise InP HEMTs

● Yasuhiro Nakasha ● Yoichi Kawano ● Masaru Sato
● Tsuyoshi Takahashi ● Kiyoshi Hamaguchi

(Manuscript received April 26, 2007)

InP-based high electron mobility transistors (InP HEMTs) exhibit a record current-gain cutoff frequency of beyond 500 GHz and an ultra low noise figure of less than 2 dB even at 100 GHz. Consequently, they are regarded as key devices for next-generation wired/wireless communication systems and precision sensors. This paper describes some fabrication techniques that enhance device uniformity for large-scale integration and provide the frequency response required for high-speed operation. It then describes two sensors that have been developed using InP HEMTs: a 94-GHz-band passive image sensor and an ultra-wideband (UWB) radar operating in the quasi-millimeter waveband of 23 to 29 GHz. By improving the performance of sensors and transceivers, InP HEMTs will accelerate the realization of advanced sensor network systems that support various social infrastructure services, for example, security, disaster prevention, and transportation.

1. Introduction

From the viewpoint of security, disaster prevention, traffic safety, and reliability improvement in infrastructure systems, sensing technologies that can detect slight changes in the environment are attracting much attention. To realize high performance sensors, various physical phenomena are used, for example, electromagnetic waves, ultrasonic waves and magnetism. Among them, electromagnetic waves of certain frequencies are attractive because they can be used to detect objects concealed by clothing and detect objects even in fog or on the other side of a wall. To enhance the resolution of imaging and the positioning accuracy of electromagnetic sensors, it is essential to increase the speed and reduce the noise of the devices used in the sensors.

High electron mobility transistors (HEMTs)¹⁾ are superior in terms of their high speed and low noise. They are used to support current sensing

and communications technologies. Familiar examples of their application are seen in 76-GHz long-range automotive radar systems²⁾ and satellite receivers. So far, gallium arsenide (GaAs) based HEMTs have been used. However, it is now necessary to use more advanced HEMTs that will achieve better performance such as those based on indium phosphide (InP).

InP HEMTs have a current-gain cutoff frequency in excess of 500 GHz, making them the fastest transistors in the world.³⁾ Also, because they feature an ultra low noise figure of less than 2 dB at 100 GHz, their performance is greatly superior to both conventional GaAs HEMTs and sub-100-nm silicon MOS devices.

Making use of these features of InP HEMTs, Fujitsu has been conducting research on digital integrated circuits such as those for the optical communications infrastructure of today's highly networked information society. We have already demonstrated the high-speed and

high-frequency performance of InP HEMTs through the development of distributed amplifiers⁴⁾ with bandwidths exceeding 100 GHz, multiplexers operating at over 144 Gb/s, and other ultra high-speed circuits.⁵⁾ The superior performance of InP HEMTs and the extensive techniques for building the high-speed, high-frequency circuits that are being cultivated should enable the creation of sensors that have a level of performance greater than ever before.

In this paper, we first discuss some state-of-the-art fabrication techniques for enhancing the uniformity of InP HEMTs integrated in a chip and for improving their speed and frequency response. We then describe two sensors that have been developed using InP HEMTs. One is a 94-GHz-band passive image sensor that can sense ultra weak millimeter waves emitted by human

bodies. The other sensor is an ultra-wideband (UWB) radar front-end that detects the distance to objects in the quasi-millimeter waveband of 23 to 29 GHz.

2. Integration and speed enhancement technologies for InP HEMTs

To enhance the high-speed and low-noise characteristics of HEMTs, it is necessary to increase the electron mobility (i.e. electron velocity) in the channel. **Figure 1** shows a cross section of an InP HEMT. Its channel features an $\text{In}_{0.53}\text{Ga}_{0.47}\text{As}$ composition with a percentage composition of In: $\text{In}/(\text{In} + \text{Ga}) = 53\%$ that achieves twice the electron mobility of GaAs. In view of the high percentage of indium in this composition, the lattice is matched to that of

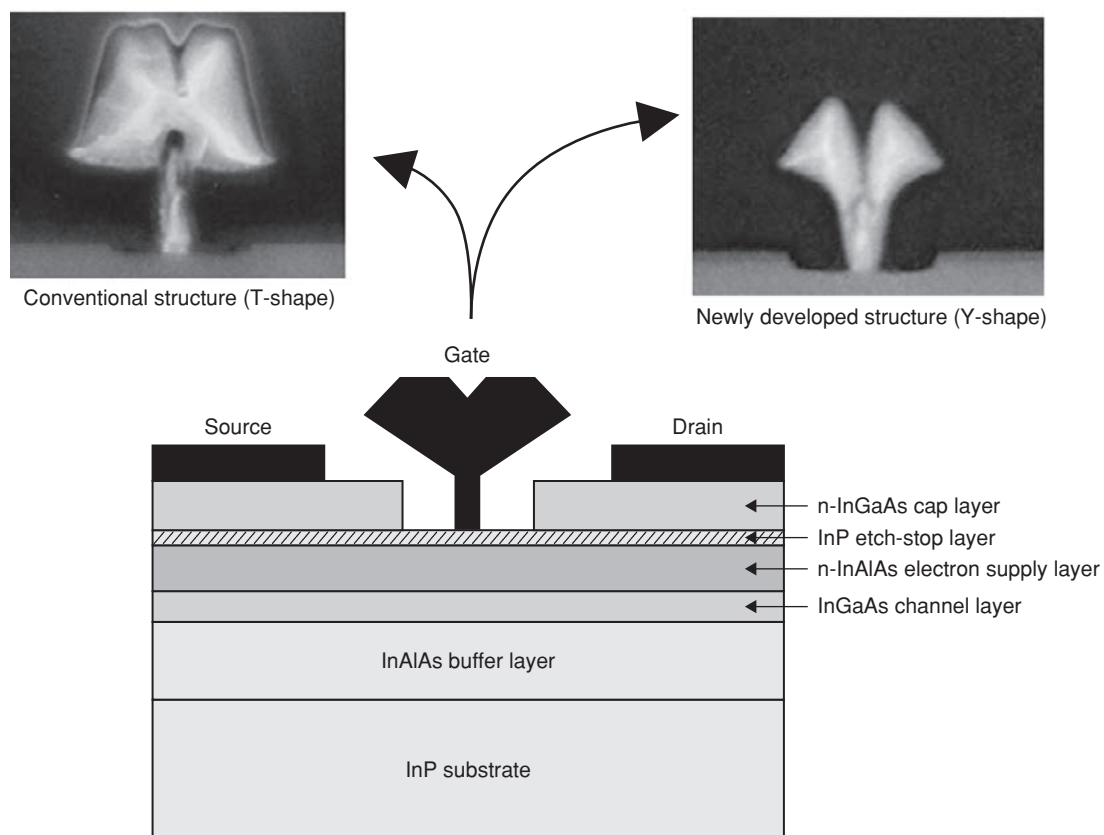

Figure 1
Cross section of InP HEMT.

the InP substrate to achieve a stable crystal quality and consequent good electrical performance. On the other hand, on a GaAs substrate, lattice mismatching causes lattice strain, which degrades the electronic performance. In general, InP HEMTs have an InGaAs channel layer and an InAlAs supply layer grown on the InP substrate. Metal organic chemical vapor deposition (MOCVD) is used for the crystal growth. The HEMT structure shown in Figure 1 achieves an electron mobility of over 9000 cm²/Vs at room temperature.

To achieve high-speed and high-frequency operation in a HEMT, it is effective to minimize the gate length and reduce gate resistance. Conventional HEMTs use a T-shaped gate structure because it provides 1) small gate contact area on the Schottky layer so the gate length can be reduced and 2) a large cross-sectional area at the gate electrode to reduce the gate resistance (Figure 1). However, this structure has the disadvantage of poor physical strength at the junction between a large top and narrow stem. To solve this problem, Fujitsu developed the Y-shaped gate structure in Figure 1. This structure is very effective in preventing the gate top from peeling off, resulting in a high yield in gate-electrode fabrication.⁶⁾ To form the gate electrode, a lift-off process technique including an electron-beam lithography and Ti/Pt/Au evaporation is employed. The typical gate length for this structure is 0.13 μm . While preserving the high-speed and high-frequency characteristics of the transistor, the Y-shaped electrode enhances uniformity and stability in an InP wafer. It has enabled more than 1000 HEMTs to be integrated in a single chip, consequently realizing a 40 Gb/s clock recovery circuit and a 40 Gb/s multiplexer with clock multiplication unit to be realized.

Next, we describe the efforts that Fujitsu has made to reduce the influence of the inter-layer dielectric film around InP HEMTs and greatly increase their speed. Benzocyclobutene (BCB) is used as the inter-layer dielectric film

to achieve a low dielectric constant ($\epsilon = 2.8$) which is advantageous to high-speed operation. With conventional structures, the gate electrode is completely covered with BCB, which increases the parasitic capacitance and impairs high-frequency characteristics. To solve this problem, Fujitsu has developed a new technique that eliminates the BCB from the gate electrode periphery and introduces the cavity structure shown in **Figure 2**.⁷⁾

This cavity structure is obtained as follows. First, the area is filled with a special filling material and the BCB dielectric film is applied to cover the filler. Then, via holes are opened on the electrodes for the source and drain. The via holes are also connected with the filler. Lastly, a solvent is applied through the via holes to dissolve the BCB-covered filler, leaving a cavity structure with no BCB inter-layer around the gate electrode.

Introducing the cavity structure greatly reduces the gate electrode parasitic capacitance. The increase in capacitance due to the BCB dielectric film is almost zero between the gate and drain electrodes, and that between the gate and source electrodes is halved.

The effectiveness of the cavity structure has also been confirmed in circuit performance. A static frequency divider fabricated with the

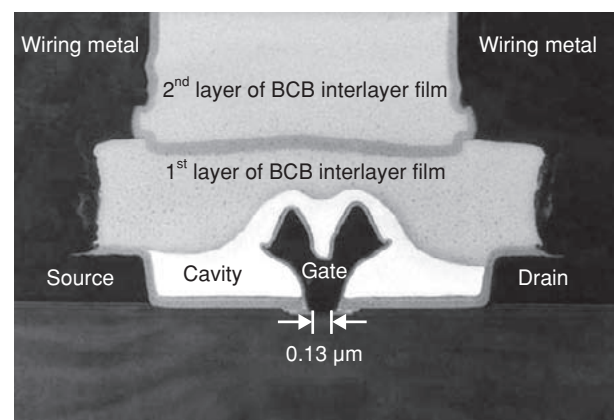

Figure 2
Cavity structure in InP HEMT.

cavity technique operated up to 90 GHz, while that with no cavities operated up to 79 GHz — which represents a speed gain of about 14%. The cavity structure is therefore effective in increasing circuit speed as well as reducing the gate length.

3. Application in passive millimeter wave image sensor

In this section, we review the application of a passive millimeter-wave image sensor using InP HEMTs. Every object radiates electromagnetic waves that depend on the object's temperature. A passive millimeter wave image sensor detects the millimeter wave radiation from the object and then visualize it. Because this type of image sensor can detect objects that cannot be detected using visible light or infrared radiation, it is widely expected to be used in security and disaster prevention applications. Millimeter waveband (30 to 300 GHz) image sensors achieve a higher spatial resolution than that of microwave image sensors because of their shorter operating wavelength and are therefore attractive because:

- 1) A high spatial resolution can be achieved in the 1 to 10 mm waveband.
- 2) Millimeter wave can pass through, for example, thin walls, clothing, and fire, enabling the imaging of a human body on the other side of objects.⁸⁾
- 3) There are few sources of radio interference in this band due to the lack of progress in the commercial use of the millimeter waveband.

On the other hand, as the wavelength becomes shorter, millimeter-wave power becomes more attenuated by the atmosphere. Therefore, the millimeter-wave image sensor is limited to short-distance use. However, at certain frequencies, such as 94 GHz, 140 GHz and 220 GHz, atmospheric attenuation is relatively small compared with that at the neighboring frequencies, and the attenuation is particularly

small at 94 GHz. We are therefore now developing a passive image sensor for the 94 GHz band because of the band's high spatial resolution and low atmospheric attenuation. In the passive image sensor shown in **Figure 3**, the millimeter-wave power from the object is focused by a lens onto a planar antenna. In the monolithic microwave integrated circuit (MMIC), which consists of a low noise amplifier (LNA) and a video detector, the received millimeter-wave power is amplified and converted to an equivalent DC voltage. A 2-dimensional image is obtained by scanning along the X and Y axes. Next, we give a detailed description of the InP HEMT LNA MMIC, which is the key component of an image sensor. The LNA for a passive image sensor must have an ultra low-noise, high-gain performance because the millimeter-wave power received by the antenna is extremely weak. Based on analysis, a noise figure of less than 5 dB and a gain of at least 30 dB are needed. If these requirements are not met, it will be difficult to obtain a meaningful image. However, such a small noise figure is impossible to obtain with current GaAs and Si transistors and MMIC technologies. Therefore, we used InP HEMTs having ultra low-noise, high-gain characteristics to develop the LNA.

Figure 4 (a) shows a photograph of a prototype LNA chip that uses InP HEMTs with a gate length of 0.13 μm . The LNA integrates a four-stage amplifier, with each stage consisting of a cascode amplifier comprising a common source transistor and a common gate transistor. In a conventional cascode amplifier, a resistor is connected to the common gate transistor to prevent from unwanted oscillations. However, this resistor behaves as a noise source and therefore deteriorates the noise performance. To overcome this problem and achieve stability and low noise, we developed a new circuit technique that uses lossless elements in place of the noisy resistor.⁹⁾ We also used a thin film microstrip to make the amplifier operate more stably.

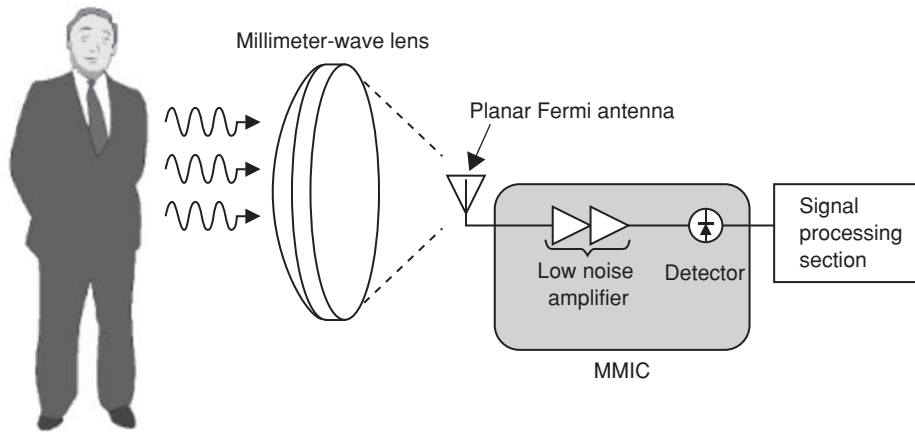

Figure 3
Block diagram of passive imaging sensor.

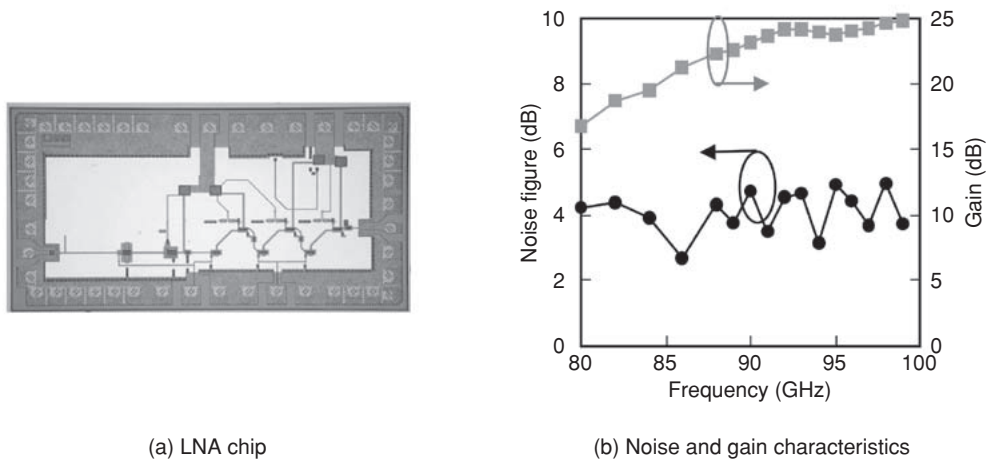

Figure 4
Electrical performance of developed low-noise amplifier.

Consequently, the new LNA is very stable and achieves very low noise figures of 3.5 to 4.3 dB in the range of 89 to 99 GHz with a gain of 23 ± 1 dB [Figure 4 (b)]. By cascading two LNA MMICs with a total gain 40 dB and a detector, we developed a prototype 94-GHz passive image sensor. Figure 5 shows a millimeter-wave image of a human body captured by the image sensor. The white area indicate warmer radiometric temperature of the body, and the black area indicates the background. As can be seen, the body and background are clearly distinguishable, which demonstrates the usefulness of the prototype

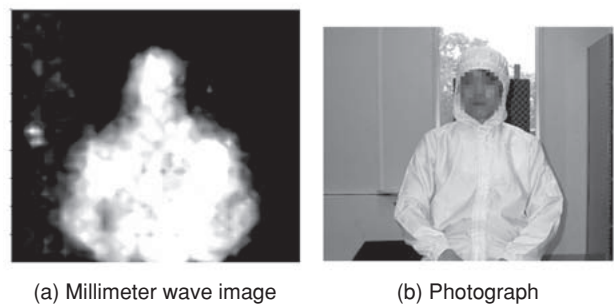

Figure 5
Millimeter wave image of human body.

passive image sensor in forming millimeter-wave images. The next step at Fujitsu is to realize an advanced receiver in which multi sensor cores are placed in an array and shorten the time needed to obtain a millimeter-wave image.

This work was supported by the Ministry of Internal Affairs and Communications under the Strategic Information and Communications R&D Promotion Programme (SCOPE).

4. Application to quasi-millimeter wave UWB radar

In this section, we review the application of InP HEMTs to quasi-millimeter wave (23 to 29 GHz) UWB radar, focusing on the RF front-end, which is a core component of UWB radar. UWB radar emits wavelet signals and detects the signals reflected by people and other objects. The distance to the object is calculated from the time it takes for the signals to reach the object and return. Because the time duration of the wavelet signals corresponds to the degree of resolution in distance measurement, the time duration must be minimized to improve resolution (**Figure 6**).

For instance, to achieve a resolution of 5 cm, the signal must have a duration of less than 330 ps. Conventionally, wavelet signals are generated by using an RF switch that switches on and off a sine wave having a frequency of 26 GHz, which is the mid frequency of the UWB range. However, with this method it is difficult to suppress signal leakage when the switch was off and simultaneously achieve rapid switching. Therefore, when the conventional method is used, it is difficult to generate short-duration wavelet signals.

To reduce the time duration of the wavelet signals, we adopted a new approach in which the wavelet signals to be transmitted are obtained by passing impulse signals through a millimeter waveband band-pass filter (BPF).¹⁰ Ideal impulses show a flat power spectrum for frequencies ranging from DC to infinity. The BPF enables us

to generate wavelet signals for transmission that have spectral characteristics similar to those of the BPF, and by carefully optimizing the BPF's characteristics, including the roll-off factors, we can make effective use of the feature of UWB radar.

Because InP HEMTs operate faster than other transistors, they can generate impulses close to ideal ones. By using a logic based impulse generator (IG) employing InP HEMTs, we can generate extremely short pulses with a full width at half maximum (FWHM) of 9 ps (**Figure 7**), which is the narrowest FWHM in the world for pulses generated using transistors.¹¹ By inputting such pulses to a quasi-millimeter wave BPF, a transmission wavelet signal with a duration of 320 ps was generated. This means that radar systems having this setup would have a spatial resolution of 5 cm.

Figure 8 shows the chipset for the prototype RF front-end that was developed by Fujitsu. In addition to the IG and BPF, a transmit power amplifier (PA), T/R switch (SW), low-noise amplifier (LNA), and sample-and-hold (SH) circuit were developed using InP HEMTs. Making the PA and SW with a distributed architecture produced an excellent gain and insertion loss flatness over a broad frequency range. The variations within the frequency range were only ± 0.1 dB. With UWB radar, because it is necessary to measure distances with extremely low power levels (less than -41.3 dBm) the receiver amplifier needs a very high gain and a low noise figure. By using five stages of the common-source circuits, our prototype LNA achieves a gain of 40 dB in a single chip with a noise figure of 1.9 dB in a chip.

We used this chipset to build a UWB radar prototype and tested its performance in a radio shielded room. The prototype was able to detect an object 10 m away with a resolution of 5 cm. For the next step, we plan to integrate the chip set into a single chip and include communication features and other features. The development of an indoor surveillance system that uses several

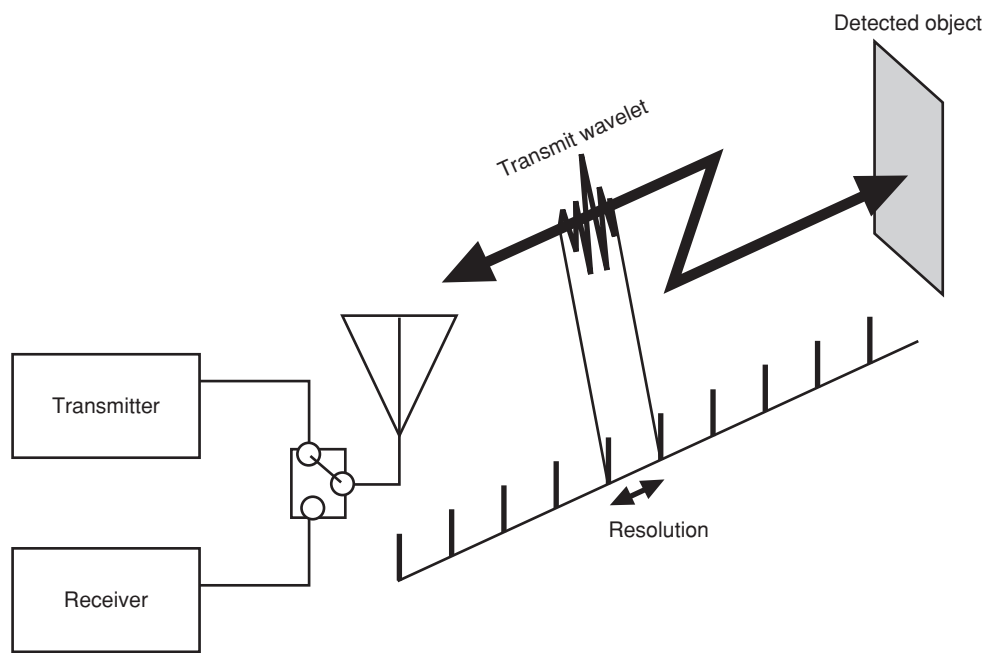

Figure 6
Ultra-wideband radar system.

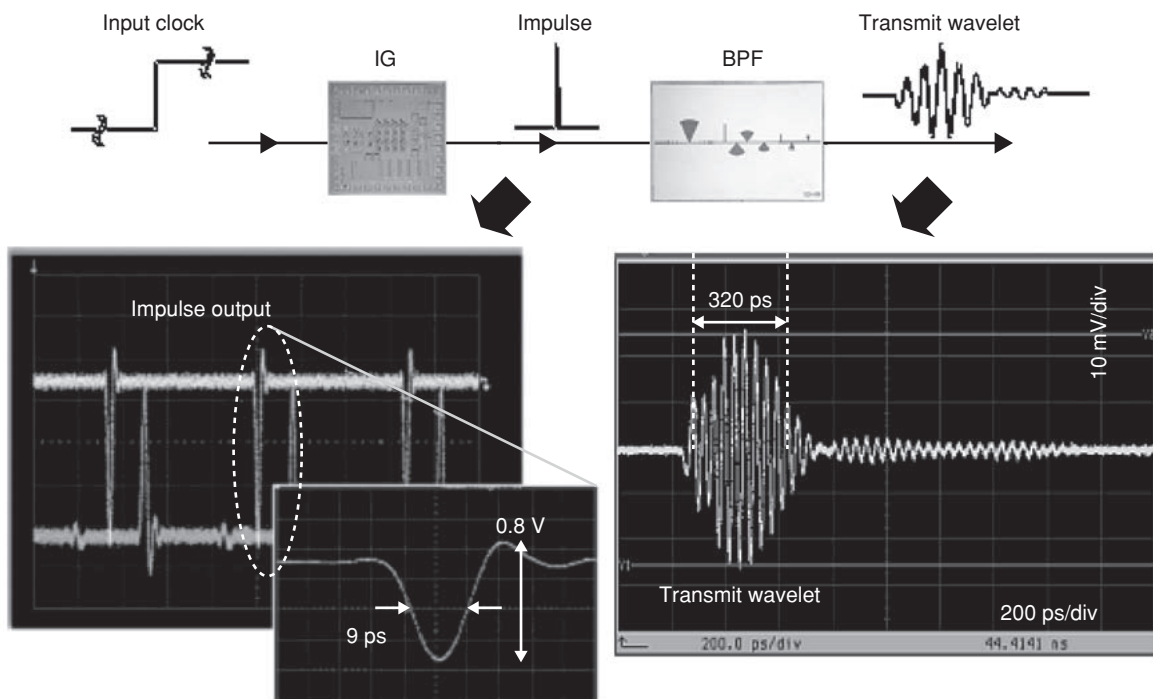

Figure 7
RF Signal generation using impulse generator (IG) and band-pass filter (BPF).

radars to position objects is a final target.

The current research was conducted in collaboration with the National Institute of Information and Communications Technology.

5. Conclusion

Fujitsu is one of the leading vendors that develop InP HEMTs. In this paper, we described an integration technique employing a Y-shaped gate electrode and a speed boosting technique involving the formation of a cavity around the gate electrodes. Then, we described a 94-GHz-band passive image sensor and a quasi-millimeter wave UWB radar as examples of recent InP HEMTs applications in Fujitsu. An ultra-low-noise amplifier having a noise figure of 3.5 dB and a gain of 23 dB that was developed for the passive image sensor enabled us to visualize a person's body. The adoption of a pulse generator with a 9 ps impulse duration (the shortest to date) in the UWB radar enabled distance measurements with a fine resolution of 5 cm.

The use of high sensitivity sensing technologies in security, disaster prevention, transportation and other infrastructure areas is expected to continue to expand in the future. Also, the integration of the sensing technologies into advanced data communications systems should proceed. Due to their ultra-high-speed and ultra-low-noise performance, InP HEMTs will accelerate the realization of the advanced sensor network systems and contribute to the development of the social infrastructure systems.

References

- 1) T. Mimura et al. : The HEMT-A Fujitsu First. (in Japanese), *FUJITSU*, **36**, 4, p.346-354 (1985).
- 2) Y. Ohhashi et al.: Development of 76 GHz Single Chip MMIC High Frequency Unit. *FUJITSU TEN TECHNICAL JOURNAL*, 19, p.23-31 (2002).
- 3) Y. Yamashita et al.: Pseudomorphic $\text{In}_{0.52}\text{Al}_{0.48}\text{As}/\text{In}_{0.7}\text{Ga}_{0.3}\text{As}$ HEMTs with an Ultrahigh f_T of 562 GHz. *IEEE Electron Device Lett.*, **23**, 10, p.573-375 (2002).
- 4) S. Masuda et al.: An Over 110-GHz InP HEMT Flip-chip Distributed Baseband Amplifier with Inverted Microstrip Line Structure for Optical Transmission Systems. *IEEE GaAs IC symposium*

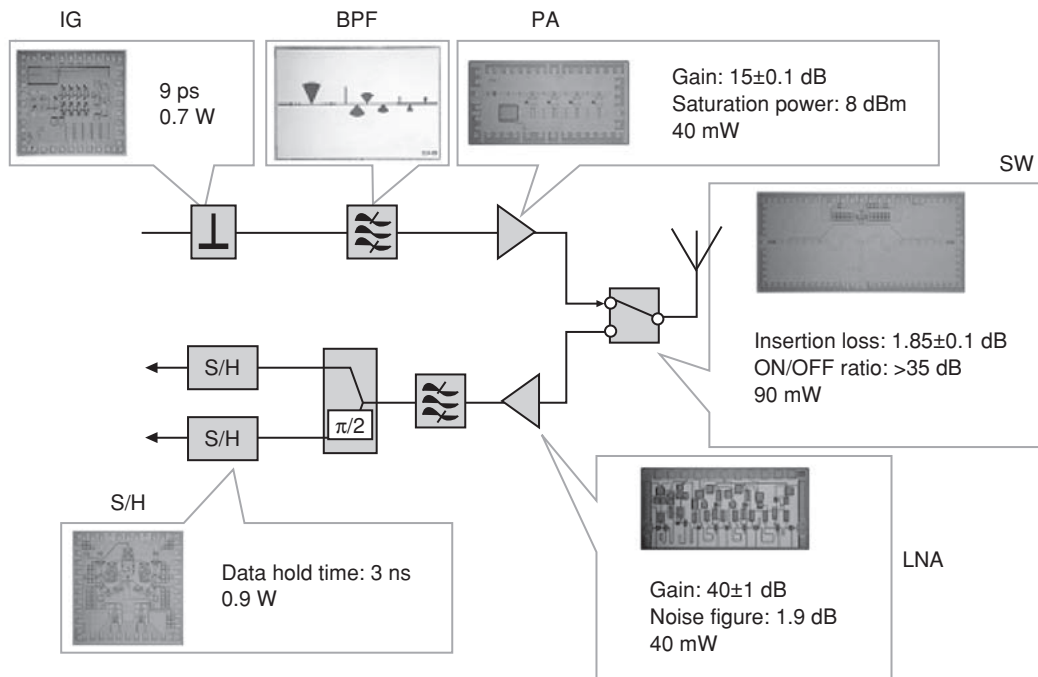

Figure 8
Chipset for RF front-end of UWB radar.

- sium Tech. Digest, 2002, p.99-102.
- 5) T. Suzuki et al.: Design and InP HEMT Technology for ultra-high speed digital ICs with beyond 80-Gbit/s operation. IEEE CSIC symposium Tech. Digest, 2004, p. 211-214.
 - 6) N. Hara et al.: Highly Uniform InAlAs-InGaAs HEMT Technology for High-Speed Optical Communication System ICs. *IEEE Trans. Semiconductor Manufacturing*, **16**, 3, p.370-375 (2003).
 - 7) K. Makiyama et al.: Improvement of Circuit-Speed of HEMTs IC by Reducing the Parasitic Capacitance. Technical Digest 2001 Int. Electron Devices Meetings, 2003, p.727-730.
 - 8) K. Mizuno et al.: New Applications of

- Millimeter-Wave Incoherent Imaging. IEEE International Microwave Symposium, 2005, p.629-632.
- 9) T. Hirose et al.: Development of a 94-GHz passive millimeter-wave image sensor. (in Japanese), Electronic Information and Communication Technical Report, ED **106**, 403, p.35-40 (2006).
 - 10) Y. Kawano et al.: RF Chipset for Impulse UWB Radar Using 0.13- μm InP-HEMT Technology. *IEEE Trans. Micro. Theory and Tech.*, **54**, p.4489-4897 (2006).
 - 11) Fujitsu Press Release. (in Japanese). <http://pr.fujitsu.com/jp/news/2006/06/13-1.html>



Yasuhiro Nakasha, Fujitsu Laboratories Ltd.

Mr. Nakasha received the B.E. and M.E. degrees in Electrical Engineering from Nagoya University, Nagoya, Japan in 1987 and 1989, respectively. He joined Fujitsu Laboratories Ltd., Atsugi, Japan in 1989 and has been engaged in research and development of compound semiconductor IC's for high-speed and high-frequency systems. He is a member of IEEE.

member of IEEE.

E-mail: nakasha-y@jp.fujitsu.com



Tsuyoshi Takahashi, Fujitsu Laboratories Ltd.

Mr. Takahashi received the B.S. and M.S. degrees in Science and Engineering from University of Tsukuba, Ibaraki, Japan in 1985 and 1987, respectively. He joined Fujitsu Laboratories Ltd., Atsugi, Japan in 1987 and has been engaged in research and development fabrication technology for InP-based HEMTs and InGaP-emitter HBTs. He is a member of the Japan Society of Applied Physics, the Institute of Electronics, Information and Communication Engineers (IEICE) of Japan.

E-mail: takahashi.tsuyoi@jp.fujitsu.com



Yoichi Kawano, Fujitsu Laboratories Ltd.

Dr. Kawano received the M.E. and D.E. degrees in Quantum Engineering from Nagoya University, Nagoya, Japan in 2000 and 2003, respectively. He joined Fujitsu Laboratories Ltd., Atsugi, Japan in 2003 and has been engaged in research and development of millimeter wave monolithic IC's and high-speed digital IC's using compound semiconductor and advanced Si CMOS technologies.

E-mail: kawano.yoichi@jp.fujitsu.com



Kiyoshi Hamaguchi, National Institute of Information and Communications Technology (NICT).

Dr. Hamaguchi received the B.Eng. and M.Eng. degrees in Electrical Engineering from Science University of Tokyo, Japan in 1989 and 1991, respectively. He also received the D.Eng. degree from Osaka University, Japan, in 2000. Since 1993 he has been with the NICT (Communications Research Laboratory, at former), where he has been engaged in research and development on digital wireless telecommunication systems. From 2002 to 2003, he was a visiting researcher at University of Southampton, U.K. He received the Young Engineer Award from IEICE, Japan in 1997, the YRP Award from the YRP R&D Promotion Committee in 2004, and the Young Scientist Award from Ministry of Education, Culture, Sports, Science and Technology, Japan in 2006. He is a member of IEEE and IEICE.

E-mail: hamaguti@nict.go.jp



Masaru Sato, Fujitsu Laboratories Ltd.

Mr. Sato received the B.S. and M.S. degrees in Electrical and Communication Engineering from Tohoku University, Sendai, Japan in 1997 and 1999, respectively. He joined Fujitsu Laboratories Ltd., Atsugi, Japan in 1999 and has been engaged in research on high-speed InP-based HEMT circuit for fiber-optic communication systems and millimeter-wave integrated circuits. He is a member of the Institute of Electronics, Information and Communication Engineers (IEICE) of Japan.

He is a member of the Institute of Electronics, Information and Communication Engineers (IEICE) of Japan.

E-mail: sato.masaru@jp.fujitsu.com