

## W.N. CHRISTIANSEN AND THE INITIAL AUSTRALIAN INVESTIGATION OF THE 21cm HYDROGEN LINE

**Harry Wendt**

*Centre for Astronomy, James Cook University, Townsville,  
Queensland 4811, Australia.*  
E-mail: Harry.Wendt@jcu.edu.au

**Wayne Orchiston**

*Centre for Astronomy, James Cook University, Townsville,  
Queensland 4811, Australia.*  
E-mail: Wayne.Orchiston@jcu.edu.au

and

**Bruce Slee**

*Australia Telescope National Facility, PO Box 76, Epping, NSW 2121,  
Australia and Centre for Astronomy, James Cook University,  
Townsville, Queensland 4811, Australia.*  
E-mail: Bruce.Slee@csiro.au

**Abstract:** On 25 March 1951 H.I. Ewen was working on his doctoral thesis at Harvard University when he detected the 21cm hydrogen emission-line (H-line). Within four months of the initial detection, small groups working in Australia and in The Netherlands were able to confirm Ewen's detection, thereby heralding a new chapter in international radio astronomy. This paper examines the Australian efforts that culminated in the confirmation of the H-line detection, and led to an initial survey of the southern Milky Way which produced the first indication of the spiral arm structure of our Galaxy.

**Keywords:** radio astronomy, hydrogen emission-line, Division of Radiophysics, W.N. Christiansen, J.V. Hindman

### 1 INTRODUCTION

By the early 1950s the CSIRO Division of Radiophysics had established itself as a leader in the new field of radio astronomy (Sullivan, 2005: 11). At this time the Division was operating a number of field stations in and around Sydney focused on both solar and cosmic research programs (see Orchiston and Slee, 2005).

When the discovery of the 21cm hydrogen emission-line (henceforth H-line) was announced, Radiophysics scientists quickly mobilised to confirm the discovery. The initial confirmation detection was made by W.N. 'Chris' Christiansen (Figure 1) and J.V. 'Jim' Hindman (Figure 2), who were working at the Potts Hill field station in the western suburbs of Sydney (Davies, 2005; Wendt, 2008). Following the confirmation, Christiansen and Hindman went on to conduct a preliminary survey of the southern Milky Way and found evidence of the spiral-arm structure of the Galaxy (Christiansen and Hindman, 1952a; 1952b).

### 2 THE H-LINE PREDICTION

Nearly all of the early major discoveries in radio astronomy, including Karl Jansky's original detection of cosmic radio emission, were serendipitous. Serendipitous discoveries in radio astronomy have been extensively discussed in the literature (see Kellermann and Sheets, 1983). Perhaps the best example of an exception to this phenomenon was the discovery of the 21cm hydrogen emission line. As Woody Sullivan (1982: 299) has noted, the prediction of the H-line was remarkable on two counts; both for its scientific prescience and for the conditions under which it was produced. Hendrik Van de Hulst was a student at the

time of the Nazi occupation of Holland and his supervisor from Utrecht University had been interned. Van de Hulst spent three months visiting Leiden (van Woerden and Strom, 2006: 17, Note 2), where under Jan Oort's guidance he examined the possibility of radio line emission from neutral hydrogen. In a paper published immediately after the war ended, van de Hulst cautiously noted the possibility of detecting an emission line:

The ground state of hydrogen is split by hyperfine structure into two levels with a separation of  $0.047 \text{ cm}^{-1}$ . The spins of the electron and proton are pointed in the same direction in one state and are opposite in the other state. A quantum of wavelength 21.2 cm is emitted due to a spontaneous flip of the spin. (van de Hulst, 1945).

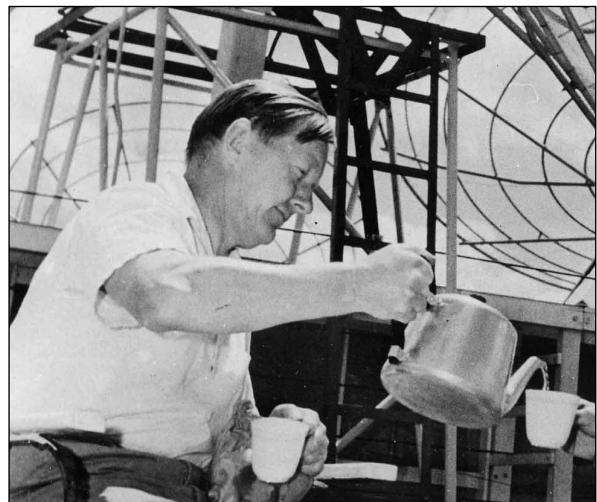

Figure 1: W.N. Christiansen at Fleurs Field Station in 1957 (courtesy: ATNF Historical Photographic Archive).

Van de Hulst noted that the transition to ground state was a forbidden transition and therefore it was necessary to assume a probability for the spontaneous transition to the preferred ground state. Provided that the life time of the hydrogen atom in the upper hyperfine-structure level was less than  $4 \times 10^8$  years, there was a possibility of detection. He also noted that the sensitivity of radio receivers would need to be improved by a factor of 100 over the 1940s levels of equipment for the emission to be detected.

The actual value of the emission frequency from the spin flip transition to the ground state is 1,420.4 MHz ( $\lambda = 21.1$  cm) and is due to the hyperfine structure transition being  $5.9 \times 10^{-6}$  eV (Wild, 1952). This is an extremely small energy level when compared (for example) to the Lyman-alpha transition of 10.19 eV which produces an emission at the much shorter wavelength of 122 nm. The probability of transition to the ground state is  $2.9 \times 10^{-15}$  sec<sup>-1</sup> ( $\sim 10^7$  years), and is within van de Hulst's original limit.



Figure 2: J.V. Hindman in 1952 (courtesy: ATNF Historical Photographic Archive).

### 3 RADIOPHYSICS PRE-DISCOVERY

The leader of the Radiophysics Radio Astronomy Group at this time was Joseph L. Pawsey. He was well aware of the potential that detecting radio spectral lines could provide. He was also familiar with the predicted 1,420.47 MHz hydrogen emission and also the prediction of deuterium emission at 237.38 MHz.

It was Grote Reber who had alerted Pawsey to the theoretical predictions and to the possibilities of detection during a visit Pawsey made to the U.S. in early 1948. Given the important implications that the detection of a radio-frequency spectral line would bring to radio astronomy, he alerted E.G. 'Taffy' Bowen (Chief of the Division of Radiophysics) to this potential in a letter dated 23 January 1948. Pawsey (1948) also included a section titled, "The Search for Atomic Spectral Lines in Noise" in the trip report he wrote following his visit to the United States. After a discussion of the potential in the report he concluded:

The position is therefore quite uncertain. Lamb of Columbia, for example, did not expect we should be able to find lines owing to low probabilities of emission or absorption and "smearing", due to changes due to magnetic fields and so on. (ibid.).

During his U.S. visit Pawsey also visited Harvard and met Oort who was visiting Yerkes Observatory at the time. However, there is no mention of any discussion on the H-line potential with these parties.

Bowen responded to Pawsey's U.S. visit report in a letter dated 18 May 1948. In this he noted:

This [atomic spectral lines] possibility is certainly an interesting one but, in view of the present state of knowledge, I doubt very much whether we should yet devote a special effort to it. A search for the atomic hydrogen and deuterium lines could be made with the Georges Heights equipment<sup>1</sup> but this would involve dislocation of other work which is scarcely justified at present. At the moment Harry Minnett is chasing up the references you supplied and we are hoping that Williamson will live up to the promise he made you to let us have a survey of the whole subject. (Bowen, 1948).

The report from Pawsey triggered some activity in Radiophysics. In early 1949, Paul Wild produced an internal report titled, "The Radio-Frequency Line-Spectrum of Atomic Hydrogen. I. The Calculation of Frequencies of Possible Transmissions." This report was a comprehensive survey of the earlier theoretical work on the subject, and Bowen noted in a letter to F.W.G. White (Chief Executive Officer of the C.S.I.R.O. and former Chief of the Division of Radiophysics) on 21 March 1949: "There is nothing very original about it but it serves to indicate the direction in which this work might go." (Bowen, 1949).

White replied to Bowen's letter on the 28 March 1949 and noted:

I have looked through it [the report] and find that, even to one who is not a spectroscopist, it is relatively easy to follow. The end results are certainly very interesting, and I hope that experimental data can now be found to which these can be related. (White, 1949).

As Sullivan (2005: 14) has reported, in 1949 Bernie Mills had considered taking on the H-line search as an independent line of research, but dismissed it as too speculative. John Bolton and Kevin Westfold had also considered searching for the H-line (Robertson, 1992: 82). They had a copy of a Russian paper translated in an effort to obtain more details, however no search was under-taken. John Murray (2007) also recalls that on a number of occasions at meetings of the Solar Noise Group Ruby Payne-Scott proposed a search for the H-line.

Despite this early insight, there was no detection attempt made by the Radiophysics Group. Westfold has attributed the lack of an immediate investigation to Pawsey's conservative nature (Robertson, 1992: 82). As late as February 1952, in a meeting of the Radio Astronomy Sub-Committee on Galactic Work, Alex Shain raised the possibility of looking for line spectra as part of the group's research efforts. In attendance at this meeting were Pawsey, Bolton, Mills, Minnett, Jack Piddington and Shain. The outcome was recorded in the minutes as: "It was decided, however, not to plan for this as it could be easily fitted into other projects." (Mills, 1951).

### 4 THE H-LINE DISCOVERY

On 25 March 1951, H.I. Ewen working on his doctoral thesis in the Lyman Laboratory at Harvard detected the 21-cm hydrogen emission-line (Ewen and Purcell,

1951). In a remarkable coincidence, van de Hulst was visiting Harvard at the time and discussed the detection with Ewen and his supervisor, E.M. Purcell. Van de Hulst indicated that the Dutch group under Oort and C.A. Muller had been attempting to detect the H-line for some time. By Ewen's own account (2003) he was unaware of the Dutch group's work and had dismissed the possibility of the Dutch actively pursuing a detection attempt because he had interpreted van de Hulst's comments in his original paper as indicating that a detection was highly unlikely. In fact, Ewen thought it likely that his thesis would indicate a negative result. Ewen believed that if anyone would undertake a detection attempt it would be a group from the Soviet Union on the basis of I. Shklovsky's (1949) independent prediction (with which Ewen was familiar).

Also visiting Harvard at this time was Frank J. Kerr from the Radiophysics Laboratory in Sydney (Kerr, 1984: 137). Kerr was on a fellowship to Harvard to undertake studies in astronomy at the Harvard College Observatory under Donald Menzel. Kerr had written to Pawsey on 17 March 1951 drawing his attention to the fact that Ewen and Cornell University's Leif Owren had made unsuccessful attempts to detect the H-line (Kerr, 1951). Owren had used an 8-ft parabola, and a receiver similar to Ewen's but with less sensitivity.

On making the initial discovery Purcell and Ewen shared details of the discovery with the Dutch group and were keen to obtain an independent confirmation of the detection. Kerr sent Pawsey an airmail letter dated 30 March 1951 alerting him to the discovery and asking if the Radiophysics group could assist in the confirmation, even though no prior work had been conducted at Sydney. The letter included a hand-drawn sketch of the H-line response on Ewen's receiver (Figure 3). In a letter dated 20 April 1951, Pawsey wrote to Purcell saying that because of the "great potentialities" he had assigned two separate groups to attempt the independent detection and they were optimistically hoping to get results "... in a few weeks". He also asked about Purcell's plan to publish the discovery, and suggested that the Radiophysics team would privately advise the Americans of any detection and then publish a confirmation note at the same time Ewen and Purcell published their result.

## 5 THE RADIOPHYSICS DETECTION

In his letter to Purcell, Pawsey had referred to "two independent groups" working on attempting a confirmation. A meeting had been held on 12 April to coordinate the activities of the Radiophysics Group in attempting a confirmation observation, and in attendance were Pawsey, Arthur Higgs, Piddington, Christiansen, Wild and Bolton. The minutes state:

It was agreed that parallel investigations to check detectability of lines were desirable in order to obtain independent checks but that, in order to avoid cut-throat competition, the groups who were experimenting in the same field, e.g. Piddington, Christiansen and Wild, should consider themselves, at least on the 1420 Mc/s line, as a single group and possible publication should be joint.

Wild outlined the theoretical results he had obtained (mainly in RPL. 33 and 34). The chief point of interest

is the existence of fine-structure lines at 10,905, 3,231 & 1,363 Mc/s with "inherent" line widths of the order of 100 and 20 Mc/s respectively.

It was agreed to recommend Wild to write up this material for publication.

Christiansen and Bolton outlined schemes for attempting to detect the 1420 Mc/s line with which they were proceeding (also corresponding deuterium line). They hope to have equipment for tests to start in a week or so.

Piddington outlined a different scheme with which he was proceeding. (Pawsey, 1951b).

Elsewhere, Orchiston and Slee (2005: 139) state that Christiansen and Hindman had been working independently at the Potts Hill field station before they discovered they had both been tasked by Pawsey to work on the same problem. This is likely a reference to the early parallel work by Piddington and Christiansen, since at the time Hindman was working with Piddington. But it is unlikely that they did not know about each other's work; rather, this was a deliberate strategy by Pawsey, as the minutes of the 12 April meeting reflect.

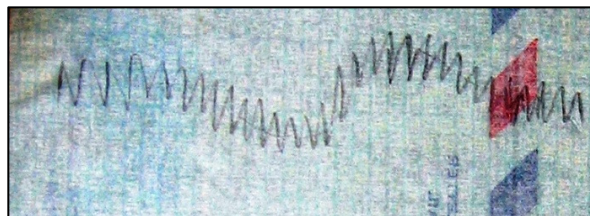

Figure 3: Hand-drawn sketch by Kerr of the H-line response detected by Ewen, included in a letter to Pawsey dated 30 March 1951 (National Archives of Australia – 972420 – C3830 – A1/3/17 Part 1).

After a short period, Christiansen took over the leadership of the group, with support from Hindman. It is unclear when Bolton's detection attempts were abandoned. However, later, in 1953-1954, an unsuccessful attempt to detect the deuterium line was made by Gordon Stanley and Robert Price using the 80-ft 'hole-in-the-ground' antenna at Dover Heights (see Stanley and Price, 1956; cf. Orchiston and Slee, 2002).

Purcell replied to Pawsey in a letter dated 9 May 1951. He welcomed the efforts of the Sydney group and provided further details of the detection and the receiver equipment. He also indicated that he and Ewen intended announcing their discovery in *Nature* "fairly soon", but would allow time for a reply before proceeding. Pawsey replied on 18 May 1951, saying that Christiansen would be, "... attempting the first observations tonight ..." and since he (Pawsey) would be away for the next fortnight Christiansen would communicate directly if the attempt was successful, although he noted it would likely take several weeks. He also suggested that Ewen might wish to publish a detailed report in the newly-created *Australian Journal of Scientific Research*.

Christiansen and Hindman (1952a: 438) were able to construct a 'makeshift' receiver very quickly thanks to a great deal of improvisation. The receiver was in principle similar to that used by Ewen and by Muller and Oort. Coupling the receiver to the 16-ft × 18-ft paraboloid at Potts Hill (Figure 4), they were able to confirm the detection by the beginning of June.



Figure 4: The 16-ft x 18-ft paraboloid at Potts Hill (courtesy: ATNF Historical Photograph Archive).

Figure 5 shows a block diagram of the major components of the receiver. It consisted of a super-heterodyne receiver with double-frequency change. It had two intermediate-frequency channels. The first operated at 30 MHz with a bandwidth of 2 MHz and the second at 5 MHz with a bandwidth of 0.05 MHz. A second heterodyne oscillator was used to continuously sweep the tuning of the receiver back and forth over a 1 MHz range. The signal from the hydrogen emission-line was detected as a small increase in signal when the pass-band of the receiver swept over the H-line frequency. As the signal increase was very small an additional balancing method was used to improve sensitivity. This was done by switching the first heterodyne oscillator at 25 Hz between two frequencies 0.16 MHz apart at around 1,390 MHz. This caused the centre frequency of the band-pass to alternate between the two frequencies and therefore allowed comparison between the signals. Any difference between the signals appeared as a 25 Hz component of the rectified receiver output. This component could then be recognised by using a selective amplifier and a phase-sensitive detector which was synchronised with the 25 Hz generator. As the receiver was tuned over the 1 MHz frequency band where detection of the H-line was predicted to appear, the energy produced by the H-line was first detected in one band-pass of the two switch components 0.16 MHz apart. This caused an in-phase 25 Hz signal. It was then detected in the other component as an out of

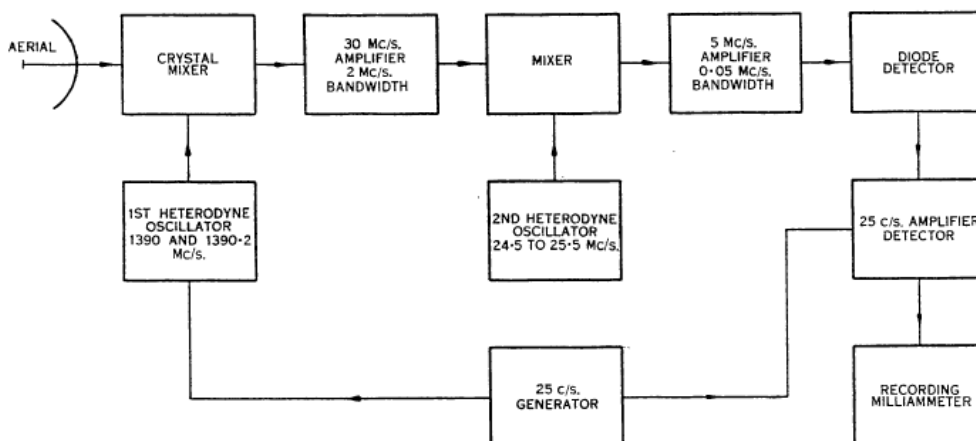

Figure 5: Block diagram of the Potts Hill H-line receiver (after Christiansen and Hindman, 1952a: 439).

phase signal. This caused a characteristic sine-wave signal on the recorder output as illustrated in Figure 6.

The receiver for the H-line detection was assembled in approximately six weeks. As Christiansen has commented:

Our research was done crudely but it was good fun and the results were exciting. When Purcell's research student Ewen came over and saw the gear I had, with cables lying all over the floor and ancient oscillators, he said, 'My God. I can understand why you could do it in six weeks and it took me two years.' (Chrompton, 1997).

And,

The fellow [Ewen] who discovered it [the H-line] in the USA came out and when he saw the equipment that Hindman and I had used for it he said, 'I can't believe it.' It looks like old rubbish lying on the floor – absolute 'string and sealing wax'. (Bhathal, 1996: 37).

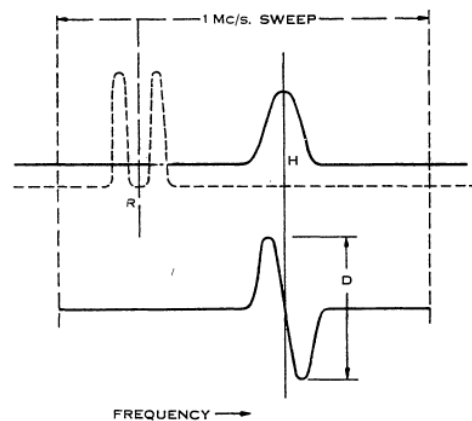

Figure 6: Illustration of H-line receiver operation and theoretical output signal. R = receiver pass-bands, H = H-line signal, D = recorder signal output (after Christiansen and Hindman, 1952a: 440).

And,

We knew when we started that our gear was so rotten it mightn't work at all. Without exaggeration it was held together with string and sealing wax; Pawsey said it kept going through sheer will power. To make matters worse sparrows kept nesting in the aerial. We were stuck out at Potts Hill reservoir and it rained like all hell all the time. After observing for 10 days, without any luck we got fed up and went home, leaving the machine switched on. The next morning we found what we were after sitting up on the chart. (Christiansen, 1954).

Figure 7 shows an example of the H-line observation obtained by Christiansen and Hindman. This can be compared and contrasted with Ewen's original observations, an example of which is shown in Figure 8.

Ewen and Purcell's discovery was published in the 1 September 1951 issue of *Nature* in a letter dated 14 June 1951, and was followed by a confirmation paper from the Dutch group dated 26 June (Muller and Oort, 1951). After the Dutch paper was a short cabled communication dated 12 July which reported the Australian detection of the H-line. This read:

Referring to Professor Purcell's letter of June 14 announcing the discovery of hyperfine structure of the hydrogen line in galactic radio spectrum, confirmation of this has been obtained by Christiansen and Hindman, of the Radio Physics Laboratory, Commonwealth Scientific and Industrial Research Organization, using narrow-beam aerial. Intensity and line-width are of same order as reported, and observations near declination 20° S. show similar extent about galactic equator. (Pawsey, 1951a).

The following day Pawsey sent Bowen a letter advising of the confirmation:

Christiansen has worked ... for the last two months trying to get this gear working and it is a very creditable performance on his part. The line is really exceedingly weak and it is necessary to make the right compromises all along the way in order to make the spectrum line evident. (Pawsey, 1951c).

**6 INITIAL H-LINE SURVEY**

Following the initial confirmation, between June and September 1951 Christiansen and Hindman proceeded to make a preliminary survey of hydrogen emission in the southern sky. The detailed findings of this survey were published in the *Australian Journal of Scientific Research* (Christiansen and Hindman, 1952a), and a summary paper appeared in *The Observatory* (Christiansen and Hindman, 1952b).

By taking a series of measurements in progressive steps of right ascension they were able to obtain a series of line profiles by declination. Figure 9 shows an example of a series of records taken along the Galactic Equator.

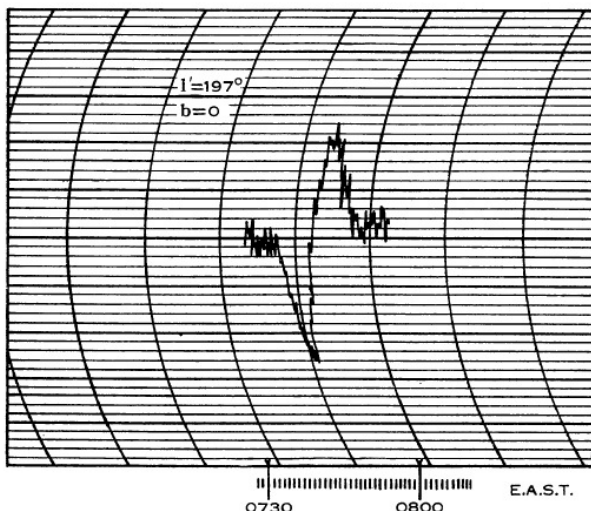

Figure 7: Example of H-line observation in the Taurus region (after Christiansen and Hindman, 1952a: 444).

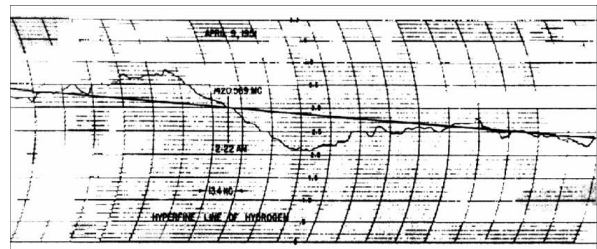

Figure 8: Example of the original H-line detection chart record made on 9 April 1951, approximately two weeks after the initial discovery (after Ewen, 2003).

From these individual records, the maximum deflection could be measured and hence a series of brightness intensities could be calculated. Figure 10 shows an example of the profile of peak brightness for the declination +10°.

By combining these profiles a contour chart of peak brightness was constructed. A peak brightness corresponding to a brightness temperature of approximately 100 K was observed. Figure 11 shows the final contour map of H-line emission. From this map it was evident there were marked variations in the peak brightness along the Galactic Equator. Christiansen and Hindman (1952a) noted that there were two likely causes of these variations, the first being due to line broadening caused by rotation of the Galaxy and the second—and more interesting possibility—was as the result of structural features in the Galaxy.

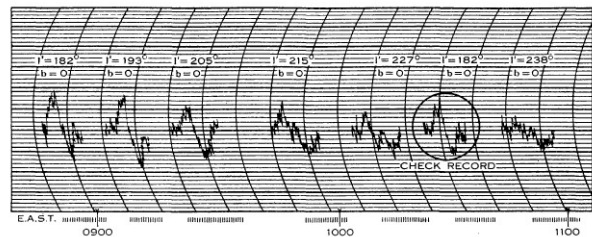

Figure 9: A series of six records taken along the Galactic Equator. A check record was performed near the end of each observing run as a check on receiver stability (after Christiansen and Hindman, 1952a: 445).

The line profiles were calculated based on the receiver response in the two swept band filters. Figure 12 shows examples of arbitrary line profiles and their corresponding receiver outputs.

The process of reconstruction of the line profiles from the receiver records was essentially the reverse of that shown in Figure 12. Figure 13 shows examples of the smoothed records and reconstructed line profiles from the Galactic Centre, the Anti-centre and Cygnus regions.

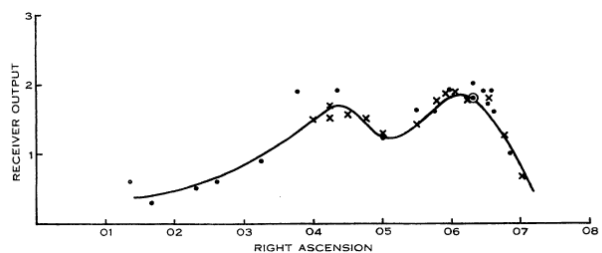

Figure 10: An example of the peak brightness profile in a strip along a declination of +10° (after Christiansen and Hindman, 1952a: 445).

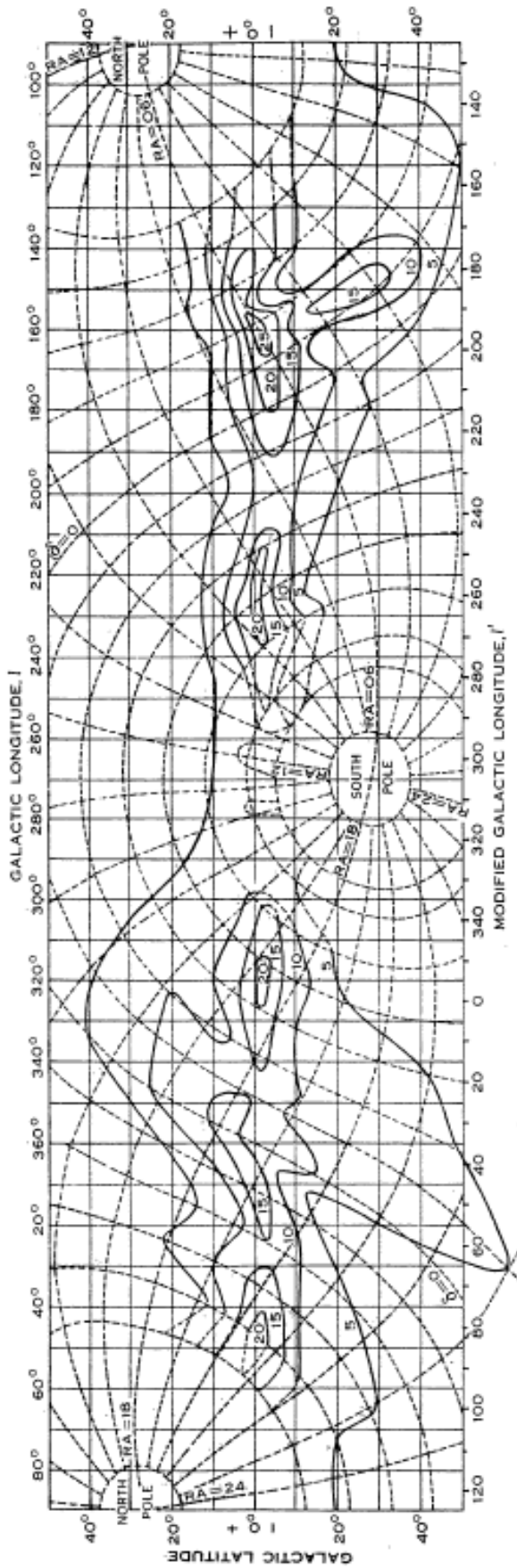

Figure 11: Southern sky contour map of H-line emission. The peak brightness of 25 units corresponds to a brightness temperature of approximately 100 K (after Christiansen and Hindman, 1952a: 446).

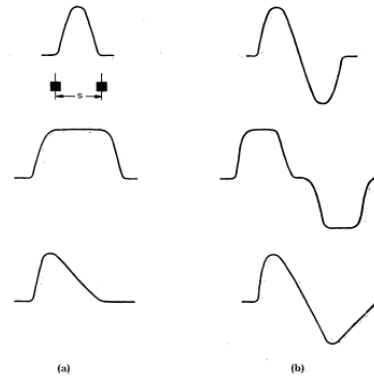

Figure 12: Example line profiles (a), and the corresponding receiver outputs (b). The sweep (s) of the two pass-bands (black boxes) is shown in the top left (after Christiansen and Hindman, 1952a: 442).

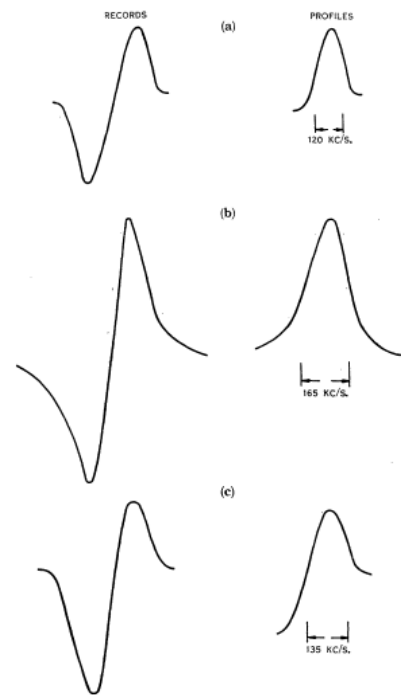

Figure 13: Examples of smoothed records and the calculated line profile in the region of the Galactic Centre (a), the Anti-centre (b) and the Cygnus region (c) (after Christiansen and Hindman, 1952a: 447).

Based on the broadening of line profiles, random velocities of the order of 12 to 18 km/s were estimated to be present in the neutral hydrogen clouds. In a number of cases double line profiles were also detected as shown in Figure 14.

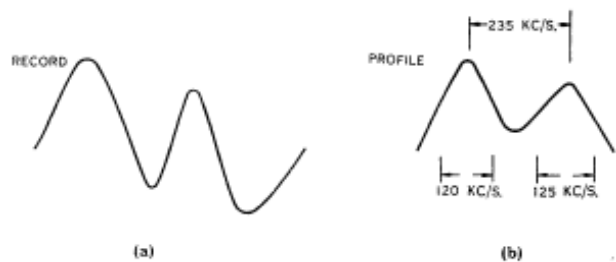

Figure 14: An example of the smoothed record and the resulting double line profile (after Christiansen and Hindman, 1952a: 448).



The existence of these double line profiles indicated regions with different radial velocities. Assuming a circularly symmetrical rotating galaxy, the radial velocity ( $v$ ) of different regions is given by:

$$v = r.A.\sin 2l' \tag{1}$$

where  $r$  is the distance of the source from the Sun,  $A$  is  $6 \times 10^{-16} \text{ sec}^{-1}$ , and  $l'$  is the modified galactic longitude with respect to the galactic centre. From this equation, given a radial velocity estimate derived from the Doppler frequency shift compared to the rest frequency, a distance to the source can be estimated. The estimate for the two major regions showing double lines was 1,000 and 4,000 parsecs. Given the large size and the constant separation of the double lines as shown in Figure 15, the structure was suggestive of spiral arms in the Galaxy.

Further evidence supporting the detection of galactic structure was found by comparing the theoretical effect of galactic rotation with the actual observations. Assuming a uniform medium producing radiation, it is possible to calculate the brightness profiles for different hydrogen densities. Figure 16 shows the theoretical plots where  $(n)$  is the number of ground state hydrogen atoms per  $\text{cm}^3$ .

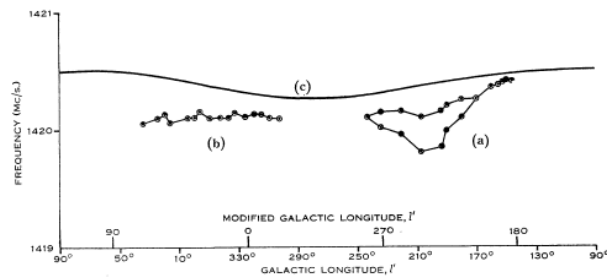

Figure 15: Plot of centre frequencies for line profiles showing double line profiles (a) and single line profile (b) regions. Line (c) is the expected frequency variation due to the Earth's relative motion (after Christiansen and Hindman, 1952a: 448).

The plot showed reasonable agreement with a density of somewhere between 1 and 0.5 atoms per  $\text{cm}^3$ . However, there were clearly regions that had factors other than rotation causing brightness variations. Also, by comparing the overall hydrogen emission to the general radio emission, which would not be effected by rotation, it is clear that there was general agreement between structural areas as shown in Figure 17. These factors suggested the existence of spiral arms in the Galaxy, and Christiansen and Hindman concluded that a much more detailed investigation was warranted.

Overall there were clear indications that the hydrogen-line emission occupied roughly the same distribution on the sky as the visible Milky Way. This association and the ability to penetrate the obscuring medium to discover Galactic structure heralded the beginning of a very important branch of investigations in radio astronomy. It also marked the beginning of a major international collaboration, particularly with the Dutch group working at Leiden, and was characterised by close cooperation that started with the prepublication communications by Ewen and Purcell to both the Dutch and Australian groups.

It is coincidental that in the same period that the breakthrough discovery of a radio frequency emission

line occurred, the first optical evidence for spiral arm structures in our Galaxy was also published (Morgan et al., 1952).

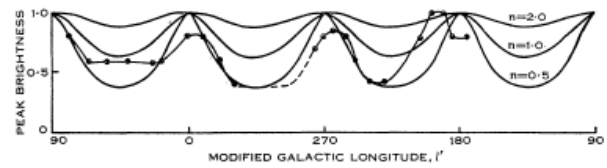

Figure 16: Calculated brightness peaks due to galactic rotation for given hydrogen densities ( $n$ ). Dots indicate actual observations (after Christiansen and Hindman, 1952a: 450).

Immediately following the Australian confirmation of the H-line, Wild decided to update and publish the internal report he had written prior to the detection of the H-line (Wild, 1952). This was a comprehensive review of the radio-frequency line spectrum of atomic hydrogen and is largely in accordance with modern theory. The report provided a very solid theoretical base for planning of further observations by the Australians. The one exception in this analysis was the conclusion that the 1,420 MHz emission would be the only detectable line emission and that it would be unlikely the higher order recombination lines would be detectable. It would be nearly two decades before the recombination lines were finally detected in the Soviet Union (Sullivan, 1982: 300).

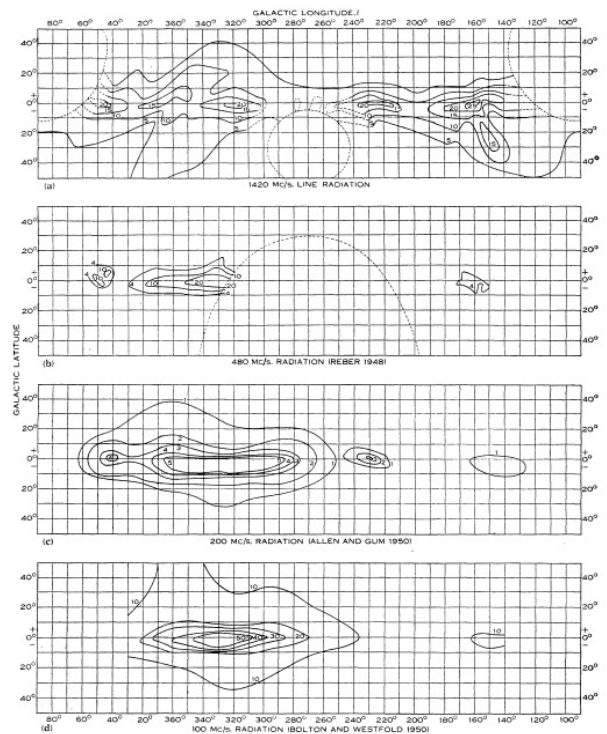

Figure 17: Comparison of H-line emission (top) and 480 MHz, 200 MHz and 100 MHz (bottom). Structural similarities are evident (after Christiansen and Hindman, 1952a: 451).

### 7 THE 1952 URSI CONGRESS

In recognition of the growing contribution of Australian researchers to the new field of radio astronomy, the Tenth General Assembly of the International Union of Radio Science (U.R.S.I) was held in Sydney from the 8 to 22 August 1952 (Haynes et.al., 1996: 222). Among those attending the Congress were Ewen from Harvard and Muller from Leiden. This meant that all

those that had been involved in the initial detection of the H-line were able to meet for the first time (see Figure 18).

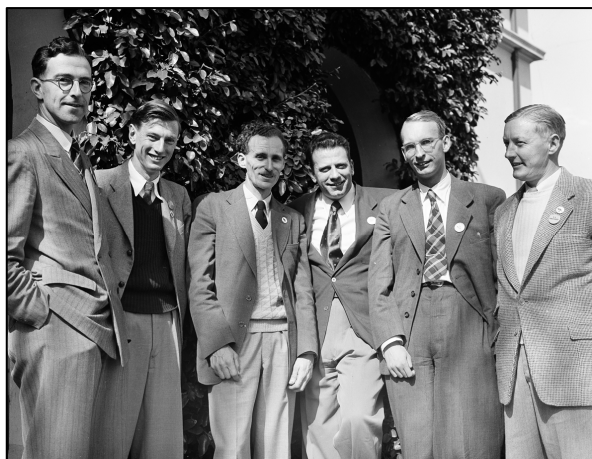

Figure 18: Gathering at the 1952 U.R.S.I. meeting in Sydney of those involved in the initial detection and confirmation of the H-line. From left to right: Kerr, Wild, Hindman, Ewen, Muller and Christiansen. Note also the special U.R.S.I. 'Kangaroo' lapel buttons being worn (courtesy: ATNF Historic Photographic Archive).

At the Congress those in Figure 18 decided to arrange a regular exchange of information by way of a newsletter that tracked the progress of the various groups undertaking H-line research. The first issue appeared in December 1952 and was circulated to those listed below in Table 1.

Table 1: Initial distribution list of the H-line newsletter.

H.I. Ewen	Ewen Knight Corporation, Massachusetts, U.S.A
B.J. Bok	Harvard Observatory, U.S.A
C.R. Burrows	Cornell University, U.S.A.
H. Tatel	Carnegie Institution, U.S.A.
J. Hagen	Naval Research Laboratory, Washington, U.S.A.
F.J. Kerr	Radiophysics Laboratory, Sydney, Australia
J.L. Pawsey	Radiophysics Laboratory, Sydney, Australia
O. Storey	T.R.E., Malvern, U.K.
A.C.B. Lovell	Jodrell Bank, U.K.
M. Ryle	Cambridge University, U.K.

## 8 CONCLUDING REMARKS

The achievement of Christiansen and Hindman in constructing a spectral-line receiver in such a short period and then using it to produce the first evidence of spiral arm structures in our Galaxy based on neutral hydrogen measurement was quite remarkable.

In retrospect, the H-line confirmation was however also a missed opportunity for Radiophysics (Sullivan, 2005: 14). Had a serious effort been made to detect the 21-cm emission line when the possibility was first raised it appears very likely that the Group would have been successful. The Group's early success in both solar and cosmic research and the wealth of discoveries made in the late 1940s and early 1950s meant that they were reluctant to pursue the more speculative search for the emission line even though they were aware of the significance that such a discovery would bring to radio astronomy.

The announcement of the discovery of the H-line also marked the first major international collaboration in radio astronomy.

After completing the initial H-line survey, Christiansen returned to his solar research program, thus ending the initial phase of Australia's H-line investigations. By this stage Kerr had returned from Harvard and he and Hindman focused on the construction a new and more reliable receiver and on a new 36-ft transit parabola for use in a dedicated H-line survey of the southern sky. They were also joined by a new graduate student, Brian Robinson, who would go on to build a distinguished international career in radio astronomy (see Whiteoak and Sim, 2006).

## 7 NOTES

1. Georges Height field station was located on a headland opposite the entrance to Sydney Harbour (see Orchiston, 2004). The equipment referred to was the 16-ft  $\times$  18-ft paraboloid which was subsequently relocated to Potts Hill for observations of the 1 November 1948 partial solar eclipse. At the time the aerial was fitted for simultaneous recording at 200, 600 and 1,200 MHz (see Orchiston, Slee and Burman, 2006; Wendt, Orchiston and Slee, 2008).

## 8 ACKNOWLEDGEMENTS

We are grateful to Kathryn Brennan from the National Archives of Australia in Sydney for help in accessing archival material and supplying Figure 3, and the Australia Telescope National Facility for providing Figures 1, 2, 4 and 18. We also wish to thank Ron Stewart (James Cook University), Richard Strom (ASTRON, The Netherlands) and Richard Wielebinski (Max-Planck-Institut für Radioastronomie) for reading and commenting on the manuscript.

## 9 REFERENCES

- Bhathal, R., 1996. Wilbur 'Chris' Christiansen - Earth Rotational Synthesis. In Miller, C. (ed.). *Australian Astronomers - Achievements at the Frontiers of Astronomy*. Canberra, National Library of Australia. Pp. 32-41.
- Bowen, E.G., 1948. Letter to Dr. J.L. Pawsey, dated 18 May. Sydney, National Archives of Australia (972098 - C3830 - A1/1/1 Part 3 Box 1).
- Bowen, E.G., 1949. Letter to F.W.G. White, dated 21 March. Sydney, National Archives of Australia (972099 - C3830 - A1/1/1 Part 4 Box 1).
- Chrompton, B., 1997. Interviews with Australian Scientists - Professor Chris Christiansen. Australian Academy of Science.
- Christiansen, W.N., 1954. Stargazers. Australian radio astronomers J.L. Pawsey and his group lead the world in this new science. *People Magazine*, 2 October.
- Christiansen, W.N., and Hindman, J.V., 1952a. A preliminary survey of 1420 Mc/s. line emission from galactic hydrogen. *Australian Journal of Scientific Research*, 5, 437-455.
- Christiansen, W.N., and Hindman, J.V., 1952b. 21cm line radiation from galactic hydrogen. *The Observatory*, 72, 149-151.
- Davies, R.D., 2005. A history of the Potts Hill radio astronomy field station. *Journal of Astronomical History and Heritage*, 8, 87-96.
- Ewen, H.I., 2003. Doc Ewen: The horn, HI, and other events in US radio astronomy. In Bouton, E. (ed.). *National Radio Astronomy Observatory: Archives: Doc Ewen*. Green Bank, National Radio Astronomy Observatory (see [www.nrao.edu/archives/ewen\\_HI\\_slides.shtml](http://www.nrao.edu/archives/ewen_HI_slides.shtml)).



- Ewen, H.I., and Purcell, E.M., 1951. Radiation from galactic hydrogen at 1420 MHz. *Nature*, 168, 356-358.
- Haynes, R., Haynes, R., Malin, D., and McGee, R.X., 1996. *Explorers of the Southern Sky. A History of Australian Astronomy*. Cambridge, Cambridge University Press.
- Kellermann, K., and Sheets, B. (eds.), 1983. *Serendipitous Discoveries in Radio Astronomy: Proceedings of a Workshop held at the National Radio Astronomy Observatory Green Bank, West Virginia on May 4, 5, 6, 1983*. Green Bank, National Radio Astronomy Observatory.
- Kerr, F. J., 1951. Letter to J.L. Pawsey, dated 17 March. Sydney, National Archives of Australia (972420 - C3830 - A1/3/17 Part 1).
- Kerr, F.J., 1984. Early days in radio and radar astronomy in Australia. In Sullivan, W.T. (ed.). *The Early Years of Radio Astronomy: Reflections Fifty Years after Jansky's Discovery*. Cambridge, Cambridge University Press. Pp. 133-165.
- Mills, B.Y., 1951. Minutes of the Meeting of the Radio Astronomy Sub-Committee on Galactic Work, 12 February. Sydney, National Archives of Australia (972135 - C3830 - A1/1/7 - Box 3).
- Morgan, W.M., Sharpless, S., and Osterbrock, D., 1952. Some features of galactic structure in the neighbourhood of the Sun. *Astronomical Journal*, 57, 3.
- Muller, C.A., and Oort, J.H., 1951. The interstellar hydrogen line at 1,420 Mc./sec., and an estimate of galactic rotation. *Nature*, 168, 357-358.
- Murray, J.D., 2007. Telephone conversation with H.W. Wendt on 5 August. Notes in Wendt Collection.
- Orchiston, W., 2004. Radio astronomy at the short-lived Georges Heights field station. *ATNF News*, 52, 8-9.
- Orchiston, W., and Slee, B., 2002. Ingenuity and initiative in Australian radio astronomy: the Dover Heights hole-in-the-ground antenna. *Journal of Astronomical History and Heritage*, 5, 21-34.
- Orchiston, W., and Slee, B., 2005. The Radiophysics field stations and the early development of radio astronomy. In Orchiston, W. (ed.). *The New Astronomy: Opening the Electromagnetic Window and Expanding our View of Planet Earth*. New York, Springer. Pp. 119-168.
- Orchiston, W., Slee, B., and Burman, R., 2006. The genesis of solar radio astronomy in Australia. *Journal of Astronomical History and Heritage*, 9, 35-56.
- Pawsey, J.L., 1948. Solar and Cosmic Noise Research in the United States, 15 April 1948. Sydney, National Archives of Australia (972132 - C3830 - A1/1/5 Part 2 - Box 3).
- Pawsey, J.L., 1951a. [Note]. *Nature*, 168, 358.
- Pawsey, J.L., 1951b. Atomic Spectral lines (Radio Frequency) - Minutes of meeting held on 12th April to discuss Laboratory programme, 24th April 1951. Sydney, National Archives of Australia (972135 - C3830 - A1/1/7 - Box 3).
- Pawsey, J.L., 1951c. Letter to E.G. Bowen, dated 13 July. Sydney, National Archives of Australia (972420 - C3830 - A1/3/17 Part 1).
- Robertson, P., 1992. *Beyond Southern Skies. Radio Astronomy and the Parkes Telescope*. Cambridge, Cambridge University Press.
- Shklovsky, I.S., 1949. Monochromatic radio emission from the Galaxy and the possibility of its observation. *Astronomicheskii Zhurnal SSSR*, 26, 10-14.
- Stanley, G.J., and Price, R., 1956. An investigation of monochromatic radio emission of deuterium from the Galaxy. *Nature*, 177, 1221-1222.
- Sullivan III, W.T., 1982. *Classics in Radio Astronomy*. Dordrecht, Reidel.
- Sullivan III, W.T., 2005. The beginnings of Australian radio astronomy. *Journal of Astronomical History and Heritage*, 8, 11-32.
- van de Hulst, H.C., 1945. Herkomst der radiogolven uit het wereldruim. *Nederlandsch Tijdschrift voor Natuurkunde*, 11, 210.
- van Woerden, H., and Strom, R.G., 2006. The beginnings of radio astronomy in the Netherlands. *Journal of Astronomical History and Heritage*, 9, 3-20.
- Wendt, H.W., 2008. The Contribution of the Division of Radiophysics Potts Hill and Murraybank Field Stations to International Radio Astronomy. Unpublished Ph.D. Thesis, Centre for Astronomy, James Cook University.
- Wendt, H., Orchiston, W., and Slee, B., 2008. The Australian solar eclipse expeditions of 1947 and 1949. *Journal of Astronomical History and Heritage*, 11, 71-78.
- White, F.W.G., 1949. Letter to E.G. Bowen, dated 28 March. Sydney, National Archives of Australia (972099 - C3830 - A1/1/1 Part 4 Box 1).
- Whiteoak, J.B., and Sim, H.L., 2006. Brian John Robinson 1930-2004. *Historical Records of Australian Science*, 17, 263-281.
- Wild, J.P., 1952. The radio-frequency line spectrum of atomic hydrogen and its applications in astronomy. *Astrophysical Journal*, 115, 206-221.

Harry Wendt, B.Sc. (Hon), M.Sc. (Astronomy), has just completed a Ph.D. at James Cook University, Townsville, Australia. His thesis topic was "The Contribution of the Division of Radiophysics Potts Hill and Murraybank Field Station to International Radio Astronomy".

Dr Wayne Orchiston is a Senior Lecturer in Astronomy at James Cook University, Townsville, Australia. His main research interests relate to Cook's voyage, Australian and New Zealand astronomical history, with emphasis on the history of radio astronomy, comets, historically-significant telescopes, early astronomical groups and societies, and transits of Venus. He has published extensively, and has edited the book *The New Astronomy. Opening the Electromagnetic Window and Expanding our View of Planet Earth* (2005). He also has a book on early Australian radio astronomy, co-authored by Woody Sullivan and Jessica Chapman, which will be published by Springer in 2009. He is the Chair of the IAU Working Group on Historic Radio Astronomy.

Dr Bruce Slee is an Honorary Associate at the Australia Telescope National Facility in Sydney, and an Adjunct Professor in the Centre for Astronomy at James Cook University. He was one of the original discoverers of the first discrete radio sources and participated in one of the first metre-wave sky surveys for radio sources, followed by measurements of their angular sizes with medium base-line interferometers. His other interests include scattering in the interplanetary medium, radio emission from active stars, absorption in the interstellar medium, pulsar research, surveys of clusters of galaxies, radio relics in clusters and, in more recent years, the history of Australian radio astronomy. Bruce is a member of the IAU Working Group on Historic Radio Astronomy, and he continues to research topics which have engaged his attention for more than 60 years.