



CRYSTAL FILTERS OSCILLATOR CRYSTALS
SYNONYMOUS FOR QUALITY
AND ADVANCED TECHNOLOGY

NEW STANDARD FILTERS

CW-FILTER XE-9NB see table

SWITCHABLE SSB FILTERS

for a fixed carrier frequency of 9.000 MHz

XF-9B 01

8998.5 kHz for LSB

XF-9B 02

9001.5 kHz for USB

See XF-9B for all other specifications
 The carrier crystal XF 900 is provided

Filter Type	XF-9A	XF-9B	XF-9C	XF-9D	XF-9E	XF-9NB
Application	SSB Transmit	SSB	AM	AM	FM	CW
Number of crystals	5	8	8	8	8	8
3 dB bandwidth	2.4 kHz	2.3 kHz	3.6 kHz	4.8 kHz	11.5 kHz	0.4 kHz
6 dB bandwidth	2.5 kHz	2.4 kHz	3.75 kHz	5.0 kHz	12.0 kHz	0.5 kHz
Ripple	< 1 dB	< 2 dB	< 2 dB	< 2 dB	< 2 dB	< 0.5 dB
Insertion loss	< 3 dB	< 3.5 dB	< 3.5 dB	< 3.5 dB	< 3.5 dB	< 6.5 dB
Termination	Z_1 500 Ω C_1 30 pF	500 Ω 30 pF	500 Ω 30 pF	500 Ω 30 pF	1200 Ω 30 pF	500 Ω 30 pF
Shape factor	(6:50 dB) 1.7 (6:60 dB) 1.8	(6:60 dB) 1.8 (6:80 dB) 2.2	(6:60 dB) 1.8 (6:80 dB) 2.2	(6:60 dB) 1.8 (6:80 dB) 2.2	(6:60 dB) 1.8 (6:80 dB) 2.2	(6:60 dB) 2.2 (6:80 dB) 4.0
Ultimate rejection	> 45 dB	> 100 dB	> 100 dB	> 100 dB	> 90 dB	> 90 dB

XF-9A and XF-9B complete with XF 901, XF 902
 XF-9NB complete with XF 903



KRISTALLVERARBEITUNG NECKARBISCHOFSHAIM GMBH
 D 6924 Neckarbischofsheim · Postfach 7

J 20 419 F

VHF
COMMUNICATIONS



A PUBLICATION FOR THE RADIO AMATEUR
 ESPECIALLY COVERING VHF, UHF AND MICROWAVES

VOLUME No. 9

AUTUMN

3/1977

DM 4.50

ULM 70

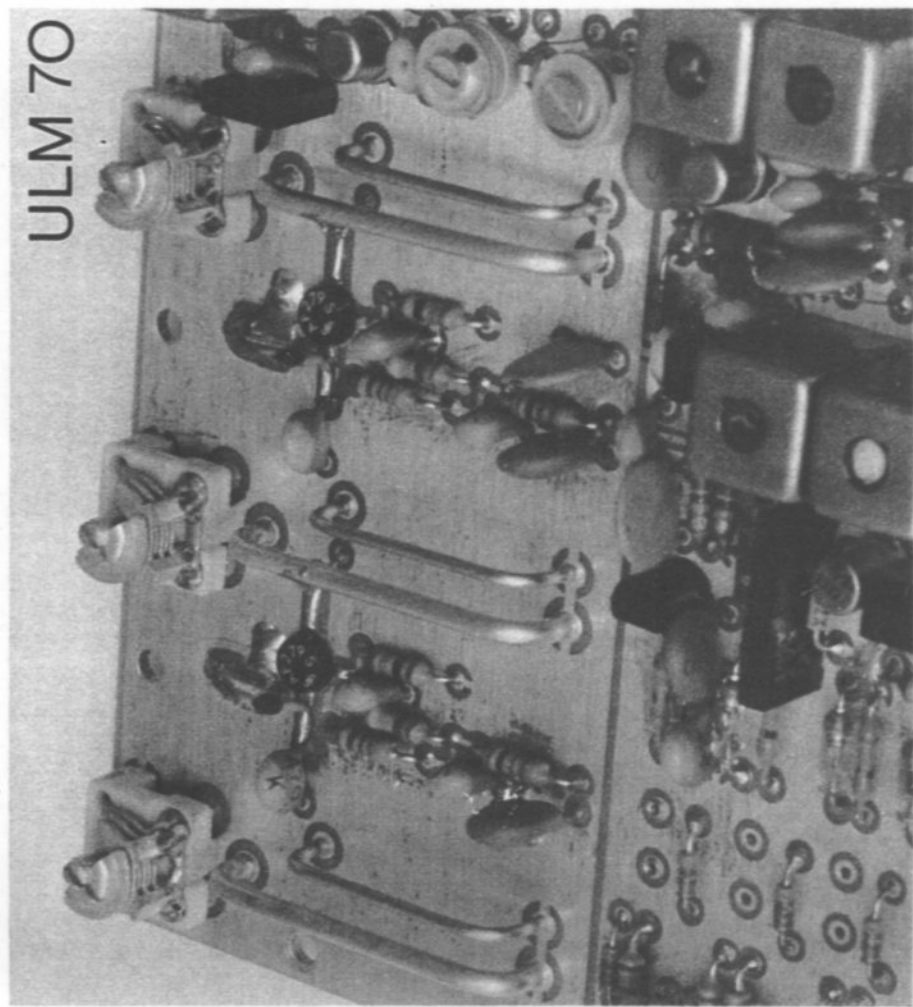



VHF COMMUNICATIONS

Published by:

Verlag UKW-BERICHTE · Hans J. Dohlius oHG · Jahnstraße 14 · D-8523 BAIERSDORF · Fed. Rep. of Germany · Telephones (0 91 33) 855, 856.

Publishers:

T. Bittan, H. Dohlius.

Editors:

Terry D. Bittan, G 3 JVQ / DJ 0 BQ, responsible for the text
Robert E. Lentz, DL 3 WR, responsible for the technical contents

Advertising manager:

T. Bittan.

VHF COMMUNICATIONS,

the international edition of the German publication UKW-BERICHTE, is a quarterly amateur radio magazine especially catering for the VHF/UHF/SHF technology. It is published in Spring, Summer, Autumn, and Winter. The subscription price is DM 16.00 or national equivalent per year. Individual copies are available at DM 4.50, or equivalent, each. Subscriptions, orders of individual copies, purchase of P.C. boards and advertised special components, advertisements and contributions to the magazine should be addressed to the national representative.

© Verlag UKW-BERICHTE 1977

All rights reserved. Reprints, translations or extracts only with the written approval of the publisher.

Printed in the Fed. Rep. of Germany by R. Reichenbach KG · Kreilingstr.39 · 8500 Nuernberg

We would be grateful if you would address your orders and queries to your representative :

VERTRETUNGEN:

Austria
Australia
Belgium
Canada
Denmark
France
Finland
Germany

Holland
Israel
Italy
Luxembourg
New Zealand
Norway
South Africa
Spain + Portugal
Sweden

Switzerland

UK
USA - East Coast

Yugoslavia

REPRESENTATIVES:

Hans J. Dohlius, Creditanstalt Bankverein WIEN Kto.17-90.599; PSchKto.WIEN 1.169.146
WIA PO Box 150, TOORAK, VIC.3142, Tel. 24-8652
Sterehouse, Brusselssesteenweg 416, B-9218 GENT, Tel. (091) 23 01 11, PCR 000-1014257-25 CCP see USA
E. Halakov, OZ 7 LX, Sigerstedt Gl. Skole, DK-4100 RINGSTED, Postgiro 7 296 800 see Sweden
Verlag UKW-BERICHTE H. Dohlius oHG, Jahnstr.14, D-8523 BAIERSDORF, Tel.09133-855,856
Konten: Postcheckkonto Nürnberg 304 55-858, Commerzbank Erlangen 820-1154, Stadtparkasse Erlangen 5-001.451 - Raiffeisenbank Erlangen 410.080
E.T.B. van Olin, PA 0 AER, Boterdiep Z.z.27, BEDUM, Tel. 05900-2394, Postgiro: 14 43 584
Z. Pomer, 4 X 4 KT, PO Box 222, K. MOZKIN 28100, Tel. 974-4-714078
STE s.r.l. (I 2 GM) Via Maniago 15, I-20134 MILANO, Tel. (02) 215 7891,Conto Corr.Post.3/44968
P. Wantz, LX 1 CW, Télévision, DUDELANGE, Postcheckkonto 170 05
E.M.Zimmermann, ZL 1 AGQ, P.O. Box 85, WELLSFORD, Tel. 8025
Henning Theg, LA 4 YG, Postboks 70, N-1324 LYSAKER, Postgirokonto 3 16 00 09
SA Publications, PO Box 2232, JOHANNESBURG 2000, Telephone 22-1496
Julio A. Prieto Alonso, EA 4 CJ, MADRID-15, Donoso Cortés 58 5-B, Tel. 243.83.84
Sven Jacobson, SM 7 DTT, Gamliakommungarden 68, S-23501 VELLINGE, Tel. 040-420430 Postgiro: 43 09 65-4
Hans J.Dohlius, Schweiz.Kreditanstalt ZÜRICH, Kto.469.253-41; PSchKto.ZÜRICH 80-54.849
VHF COMMUNICATIONS, Communications House, 20, Wallington Square, Wallington, Surrey
915 North Main St., JAMESTOWN, NY 14701, Tel. 716 - 664 - 6345
Tito Cvrtković, YU-56000 VINKOVCI, Lanjinova 36

WIDEBAND OMNIDIRECTIONAL DISCONE ANTENNA

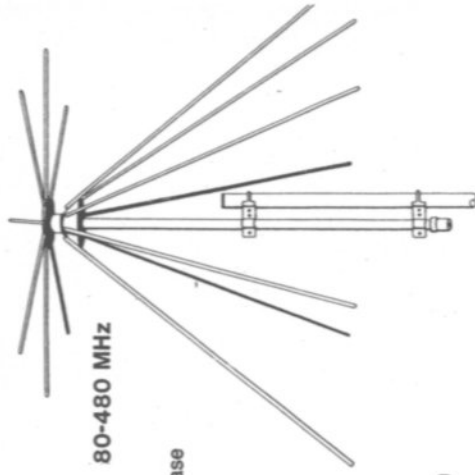

- Frequency range: 80 - 480 MHz
- Gain: 3.4 dB / λ/4
- Impedance: 50 Ω
- Power rating: 500 W
- Polarisation: Vertical
- Connection: SO 239 in water proof case
- VSWR: < 1.5 : 1
- Weight: 3 kg
- Dimensions: Height: 1.00 m
Diameter: 1.30 m
- Material: Aluminium
- Mounting: 2 mast clamps provided

80-480 MHz

Horizontal Rotator KR 400

High precision rotator for 50 Hz

- Long life
- Reliable operation

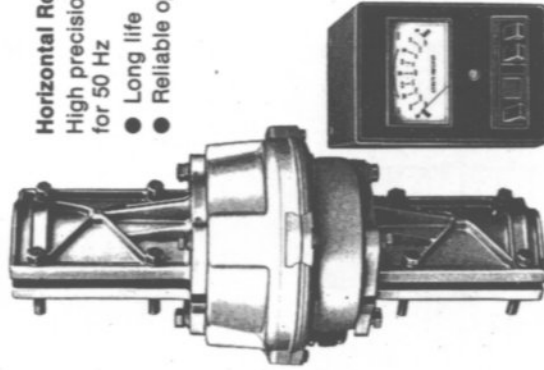

Type KR 400

- Load 200 kg
- Brake torque 196 Nm *)
- Torque 40 Nm *)
- Mast diameter 38 - 63 mm
- Speed (1 rev.) 60 s
- Rotation angle 370°
- Control cable 6 wires
- Line voltage 220 V/50 Hz 50 VA
- Dimensions (mm) 270 x 180 Ø
- Weight 4.5 kg

*) 1 kpm Δ 9.81 Nm

Both rotators designed for 50 Hz operation.

Vertical Rotator KR 500
Especially designed for vertical tilting of antennas for EME, OSCAR etc.

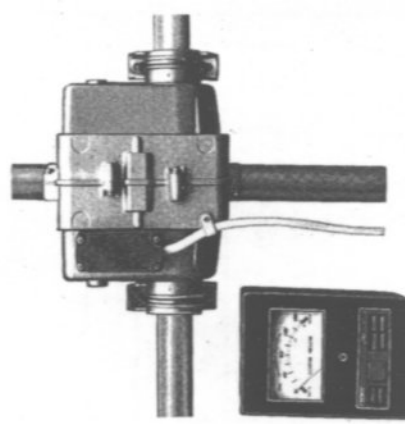

Type KR 500

- Load ca. 400 kg
- Brake torque 197 Nm *)
- Torque 40 Nm *)
- Horiz. tube diam. 32 - 43 mm
- Mast diameter 38 - 63 mm
- Speed (1 rev.) 74 s
- Rotation angle 180° (+ 5°)
- Control cable 6 wires
- Line voltage 220 V/50 Hz 30 VA
- Weight 4.5 kg

NEW ANTENNA ROTATING SYSTEMS from UKW-TECHNIK

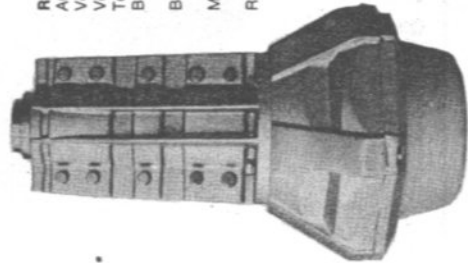

Rotator UKW 8000
 AC voltage: 220 V / 50 Hz
 Voltage to rotator: 42 V / 50 Hz
 Vertical load: 2500 kg
 Torque: 25 mkp = 245 Nm
 Brake torque:
 140 mkp = 1373.4 Nm
 Bending moment:
 250 mkp = 2452.5 Nm
 Mast diameter:
 48 to 76 mm
 Rotator weight: 26 kg

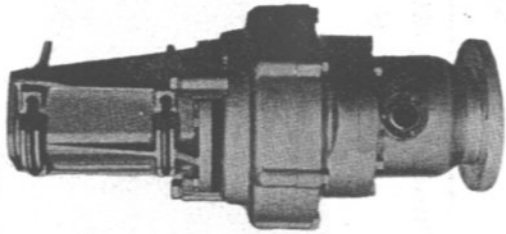

Rotator UKW MXX 1000
 AC voltage: 220 V / 50 Hz
 Voltage to rotator: 42 V / 50 Hz
 Vertical load: 1000 kg
 Torque: 18 mkp = 176.5 Nm
 Brake torque:
 120 mkp = 1177.2 Nm
 Bending moment:
 165 mkp = 1618.7 Nm
 Mast diameter:
 38 to 62 mm
 Rotator weight: 12.7 kg

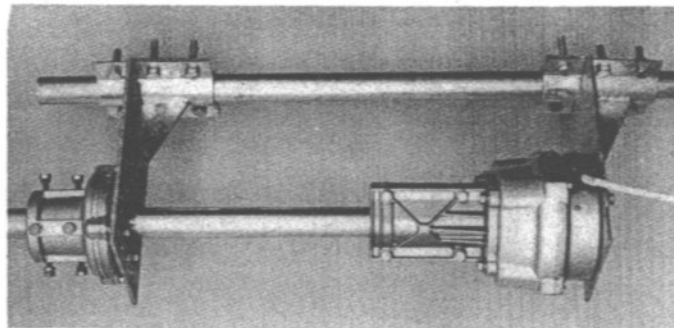

Antenna rotating system as described in 1/1977 of VHF COMMUNICATIONS

We have designed an antenna rotating system for higher wind loads. This system is especially suitable when it is not possible to install a lattice mast. The larger the spacing between the rotator platforms, the lower will be the bending moment on the rotator. This means that the maximum windload of the antenna is no longer limited by the rotator, but only by the strength of the mast itself and on its mounting. Please request the prices either from your National representative, or direct from the publishers.

This system comprises:
 Two rotator platforms
 One trust bearing
 One KR 400 rotator, or other rotator.

UKW-TECHNIK · Hans Dohls oHG
D-8523 BAIERSDORF · Jahnstraße 14
Telephone (09133) - 855, 856 · Telex: 629 887

Bank accounts: Postcheck Nürnberg 30 455 - 858
 Commerzbank Erlangen 820-1154

A PUBLICATION FOR THE RADIO AMATEUR
 ESPECIALLY COVERING VHF, UHF AND MICROWAVES
 VOLUME No. 9 AUTUMN EDITION 3/1977

I. Sangmeister, DJ 7 OH H.J. Franke, DK 1 PN H. Bentivoglio, DJ 0 FW	The 70 cm FM Transceiver „ULM 70“ Part 2: The Receiver	130 - 142
H.J. Brandt DJ 1 ZB	Selective Frequency Multipliers	143 - 151
H.J. Brandt DJ 1 ZB	A Simple Bandpass Filter for the 70 cm Band	152 - 156
G. Hoch DL 6 WU	YAGI ANTENNAS – Principle of Operation and Optimum Design Criteria	157 - 166
T. Kölpin DK 1 IS	Further Data for Construction of Horn Antennas for the 10 GHz Band	167
B. Heubusch, DC 5 CX Dr.ing. A. Hock, DC 0 MT H. Knauf, DC 5 CY	A Transceiver for 10 GHz Part 2	168 - 178
R. Reuter DC 6 PC	Linear Capacitance Meter	179 - 183
G. Hoffschild DL 9 FX	The AFC Loop – A Simple and Cheap Method of Obtaining Stable VHF Frequencies	184 - 188
Editor	Notes and Modifications	189

THE 70 cm FM TRANSCEIVER »ULM 70«

Part 2: The Receiver

by I. Sangmeister, DJ 7 OH · H.J. Franke, DK 1 PN · H. Bentivoglio, DJ 0 FW

Part 1 of this article gave a description of four possible variants of this UHF FM transceiver for the 70 cm band (Edition 2/77). The concept of the receiver has already been explained together with the block diagrams. The receiver module is used in all four variants, with slight modifications for the synthesizer version D.

A photograph of the completed receiver board is shown in **Figure 6**. It is possible for this board to be used on its own, since its audio output is in the order of 100 mV. Some features of the circuit are to be discussed in detail together with the overall circuit diagram of the receiver given in **Figure 7**.

This is followed by the construction details for the PC-board and alignment information for the receiver module.

2. CIRCUIT DESCRIPTION OF THE RECEIVER

2.1. Oscillator and Multiplier

The oscillator must be stable enough that the frequency error only amounts to one to two tenths of the receive bandwidth, e.g. a maximum of 3 kHz, in the case of normal temperature and voltage fluctuation, in order to ensure that it is not necessary to keep retuning the receiver. In principle, it would be possible to use a VFO, however, it would be very expensive. Especially the temperature compensation would require special measures, and considerable patience and time. Only a crystal-controlled oscillator is suitable for a really reproduceable unit.

In order to obtain this in the easiest possible manner and with the greatest reproduceability, an oscillator circuit was selected without inductance where the crystal oscillates in a parallel-resonance circuit. This circuit represents a compromise between switching and pulling. In many transceivers, oscillators can be found that are diode-switched and possess ten or more crystals. However, they are very difficult to modulate and it is virtually impossible to pull the frequency using varactor diodes. On the other hand, there are good VXO-circuits equipped with a single crystal (1) that are so difficult to switch that it would be simpler to use a separate oscillator for each crystal.

The crystal frequencies are in the order of 16 MHz and are thus in the cheapest price range. Unfortunately, these crystals are not available with defined frequency-pulling characteristics. The lowest crystal frequency requires three frequency multipliers (x 27) in order to obtain the 70 cm band. In spite of the bandpass filter coupling between the stages, it is not possible to completely avoid spurious signals.

The crystals are connected to the collector of the oscillator transistor T 10 via switching diodes. The collector current flows through the diode that is connected to the positive operating voltage via the 560 Ω resistor. The other diodes are blocked and are only effective

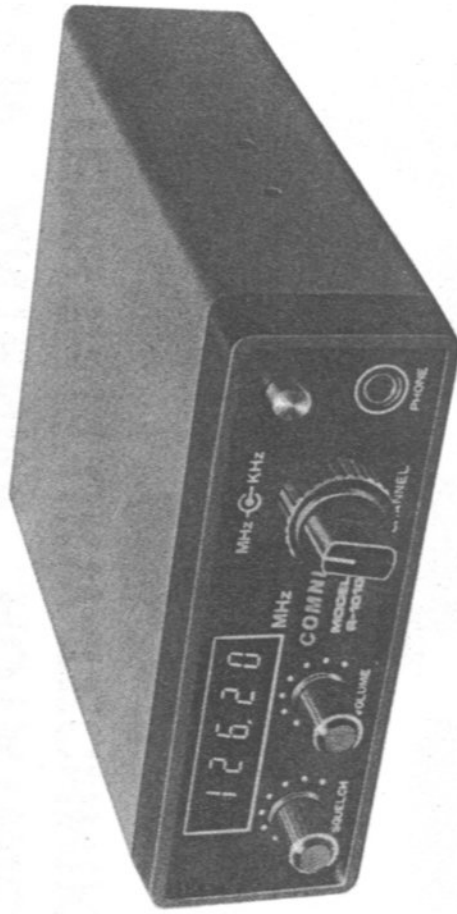

COMNI R-1010

1120 Channel VHF Airband Receiver with Synthesizer

FEATURES:

- 1120 channels for NAV/COM with 25 kHz spacing
- Exact frequency selection of MHz and kHz
- Electronic digital readout
- Small and handy
- Extremely sensitive double superhet
- For AC and battery operation (Connection cables provided)

SPECIFICATIONS:

Frequency range:	108.000 - 135.975 MHz
Receive channels:	1120
Channel spacing:	25 kHz
Modulation mode:	AM (A 3)
Sensitivity:	< 0.5 μV / 20 dB (S + N)/N
Bandwidth:	15 kHz
Intermediate frequencies:	10.695 MHz / 455 kHz
Oscillators:	1st: PPL-synthesizer, 2nd: crystal
Spurious and image rejection:	Better than - 60 dB
Control time (AGC):	0.1 - 0.5 s
Built-in effective noise blanker:	Especially designed for mobile use
Input connector:	50 Ω, SO 239
Temperature range:	- 20°C to + 60°C
Audio output:	> 1.5 W / < 5% distortion
Built-in loudspeaker:	8 Ω, approx. 60 mm dia.
Operating voltages:	13.8 V ± 15% / 220 VAC 50 Hz
DC-current drain:	0.8 A
Dimensions:	160 x 56 x 250 mm
Weight:	approx. 3 kg
Supplied accessories:	Power line cable, battery cable, telescope antenna, mobile mount.

MATERIAL PRICE LIST OF EQUIPMENT described in Edition 3/1977 of VHF COMMUNICATIONS

DJ 0 FW 001	RECEIVER	Ed. 3/1977
PC-board	DJ 0 FW 001 (double coated, thru-contacts)	DM 32,—
Semiconductors	DJ 0 FW 001 (10 transistors, 1 IC, 11 diodes)	DM 79,—
Minikit 1	DJ 0 FW 001 (7 coils, 2 ferrite chokes, 5 trimmer caps.)	DM 52.50
Minikit 2	DJ 0 FW 001 (50 ceramic bypass caps., 2 tantalum caps., 18 ceramic caps., 53 resistors, 1 trimmer potentiometer)	DM 38,—
Crystal filter	DJ 0 FW 001 (10.7 MHz)	DM 30,—
Crystal	HC-18/U Channels R 69 - 72, R 72 - 75, R 75 - 78, R 78 - 81, R 81 - 84, R 84 - 87, crystals each	DM 16,—
Set of crystals	HC-18/U Any four of above crystals	DM 60,—
Complete kit	DJ 0 FW 001 with above parts (incl. set of crystals)	DM 285,—
DC 0 MT 001/002	POWER SUPPLY and MODULATOR for Gunn-Oscillators	Ed. 3/1977
PC-board	DC 0 MT 001 (without plan)	DM 6.50
PC-board	DC 0 MT 002 (without plan)	DM 9.50
Semiconductors	DC 0 MT (1 TDA 1037, 1 Gunn diode DBG 6844 A, 1 diode 1 N 23 E)	DM 77,—
Kit	DC 0 MT 001/2 with above parts	DM 91,—
DJ 1 ZB 002	70 cm BANDPASS FILTER	Ed. 3/1977
Kit	DJ 1 ZB 002 (1 silver-plated case, 4 silver-plated solder tags, 2 trimmers, 2 BNC connectors, silver-plated copper wire)	DM 49,—
DC 6 FC 002	CAPACITANCE METER	Ed. 3/1977
PC-board	DC 6 FC 002 (with printed plan)	DM 9,—
Semiconductors	DC 6 FC 002 (1 IC, 2 transistors)	DM 10,—
Kit	DC 6 FC 002 with above parts	DM 19,—

Verlag UKW-BERICHTE, H. Dohlus oHG
Jahnstraße 14 – D-8523 BAIERSDORF

West-Germany · Telephone (0 91 91) 91 57 or (0 91 33) 855, 856

Bank accounts: Postcheck Nürnberg 30455-858 · Commerzbank Erlangen 820-1154
 Stadtparkasse Erlangen 5-001.451 · Raiffeisenbank Erlangen 410.080

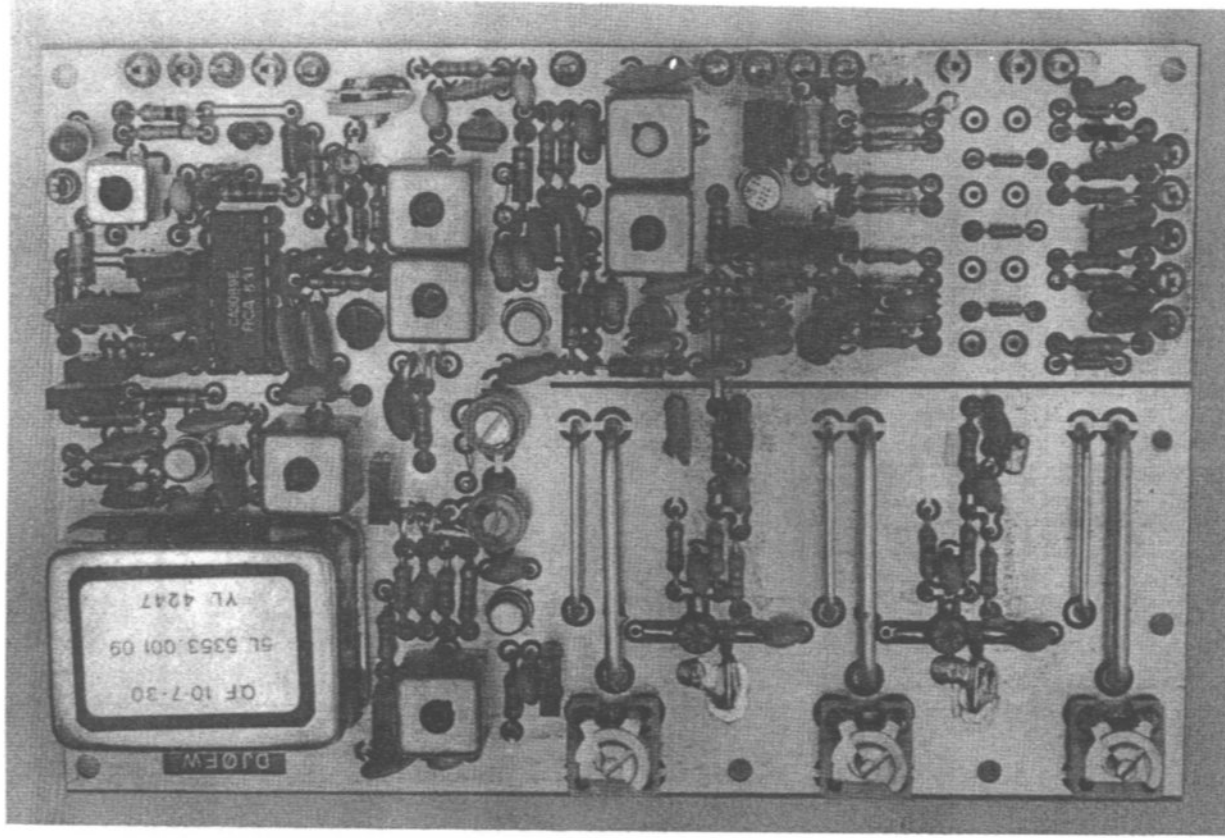

Fig. 6: Photograph of the completed receiver board

NOTES AND MODIFICATIONS

1. NEUTRALISATION OF THE 500 MHz PRESCALER DJ 6 PI 005

A tendency to oscillation was observed with some models of the 500 MHz prescaler DJ 6 PI 005. It is observed when the input connector is unterminated as a flickering counter read-out in the order of 250 MHz, and is even visible when the supply voltage of the OM 335 has been switched off. This effect was firstly thought to be caused by low-quality SP 8515, however, it is caused by especially good types. It will be seen in the data sheet that the maximum sensitivity of the SP 8515 is in the order of 250 MHz. For this reason, the manufacturers (Plessey) state that a tendency to oscillation in this frequency range is possible.

Any tendency to oscillation can be neutralized simply by placing a resistor between the input of the SP 8515 (pin 10) and ground. The resistance value must be found experimentally for each individual IC. After switching off the supply voltage of 24 V, one commences with a value of 100 k Ω and the value is reduced until a stable 000 read-out is available on the counter. Even with the lowest possible values in the order of 15 k Ω , the sensitivity of the prescaler will hardly be affected: for instance from 2 mV to 3 mV at 400 MHz.

In addition to these measures, the following should also be observed:

The outer conductor of the coaxial cable between the input socket and board DJ 6 PI 005 should be grounded at both ends.

The output of the module should not be connected to a high impedance input, but directly connected to the counting gate (usually a 74 S 00).

Since this tendency to oscillation was not observed with any SP 8515 types used in the prototypes and before publication of the article, no room is available on the board for this damping resistor. However, it can easily be mounted on either side of the board between pin 10 and ground.

Another unwanted effect is that a harmonic of low frequency signals will be indicated at input voltages over approximately 1 V. This overload effect can be avoided by using an extensive control circuit using PIN diodes. In order to avoid this, it should be noted that the prescaler should be driven with the lowest possible voltage, or via an attenuator.

2. A TRANSCEIVER FOR THE 10 GHz BAND

In the case of the Gunn diodes type DGB-6844 A supplied by the publishers, the anode is connected to the heat sink (flange). This side must be connected to the minus pole of the power supply. If the output voltage from the modulator is negative, a galvanic coupling to this Gunn-element will be possible. If not, a transformer must be used as described by DC 0 MT.

3. DC 8 NR LINEAR TRANSVERTER 144 MHz - 1296 MHz

An output power of maximum 1 W can be obtained by tuning the coupling links in the linear amplifier to the required frequency. This can be obtained by providing small copper foil strips of approximately 5 mm x 10 mm to the hot end of the coupling links, which are then tuned by altering the capacitance of these strips to the screening walls. Inductance L 3 should be tuned to 1152 MHz, L 5 and L 7 to 1296 MHz.

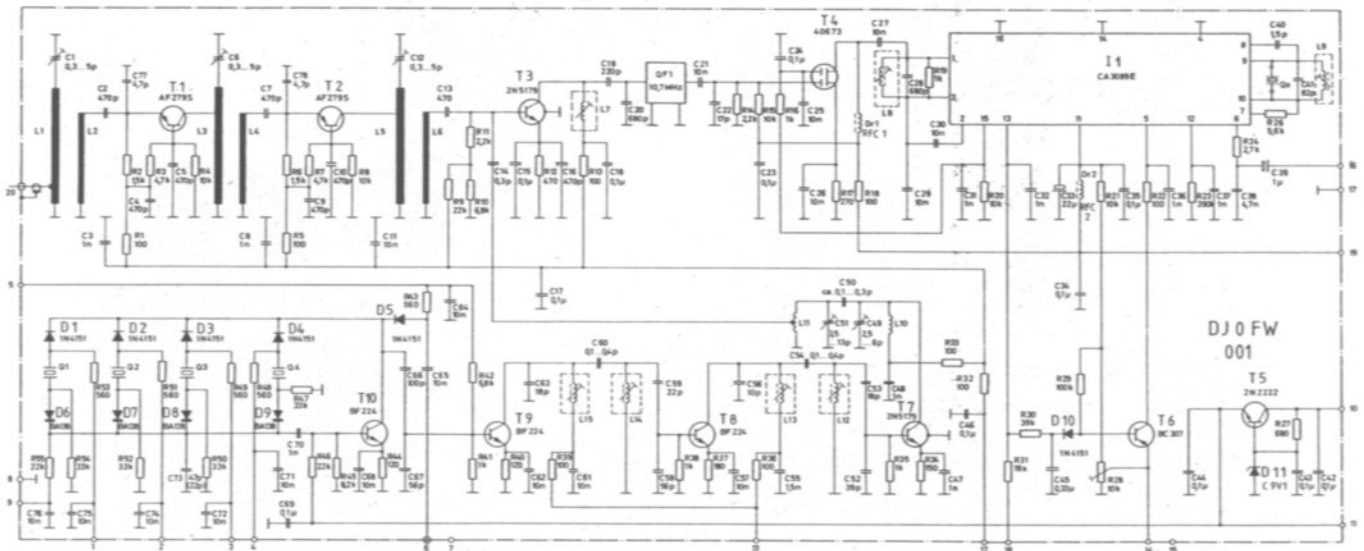

Fig. 7: Complete circuit diagram of the receiver module

It is known that the interference effects will be reduced to the value of the factor fb. If the control loop is designed correctly the following values can be assumed:

$$G = 200,000; \alpha = 1$$

$$\text{thus } fb = \frac{1}{1 + 200,000} \approx 5 \times 10^{-6}$$

If the oscillator is detuned due to external effects (e.g. temperature, load) and the control loop is open, this detuning effect will be reduced by factor 5×10^{-6} when the control loop is connected. For instance, this corresponds to 1 MHz to 5 Hz.

5. SHORT-TERM STABILITY

The short-term stability is mainly dependent on the quality of the VCO. Its short-term behavior is, however, that of a self-excited oscillator, and cannot be improved when using a control loop having a low cutoff-frequency. Since the frequency plan for the SSB mode must be made in a different manner due to the filter method mainly used, the described system only has practical applications for the FM-mode.

6. FINAL CONSIDERATIONS

The above considerations have shown that a variable frequency of sufficient accuracy and stability can be generated with a moderate amount of circuitry. The frequency control loop should therefore be advantageous when frequency bands are to be tuned linearly, or in defined steps.

A prototype covering the frequency range of 145.0 to 145.825 MHz in 25 kHz steps for both repeater and simplex operation, proved that these considerations are correct. The whole control loop (without voltage divider for the reference voltage and voltage stabilizer) was installed in a case having the dimensions 100 mm x 52 mm x 30 mm. The current drain amounted to approximately 35 mA at an operating voltage of 9 V which means that the oscillator is suitable for use as oscillator module in a portable FM-station.

FOURTH FRENCH EDITION OF VHF COMMUNICATIONS

There are now four French editions of VHF COMMUNICATIONS available. Please contact the publishers or our French representative for more details:

Mlle. **Christiane MICHEL** · Les Piliés · F-89117 PARLY (France)

Please inform your French speaking friends of these omnibus editions of VHF COMMUNICATIONS.

with their blocking capacitance of approximately 2 pF. This capacitance together with the circuit capacitance means that each crystal requires its own varactor diode for pulling. The point between the varactor diode and the crystal is the highest impedance (hottest) point of the circuit. If the crystals are connected to a single varactor diode at this point, the coupling will be so great that it will not be possible to tune satisfactorily. The other, relatively low impedance poles of the varactor diodes are connected together at the base of the oscillator transistor.

When using an intermediate frequency of 10.7 MHz, the frequencies required for the transmit and receive mode are very near to each other. If the bandpass filters of the multiplier chain are sufficiently wide, it is possible for the oscillator frequencies for transmitter and receiver to be generated in the same oscillator chain. Such a transceiver was designed by DJ 7 OH and has been in operation since 1975. The circuit extract given in **Figure 8** shows how the receive mixer and transmit amplifier input are connected in parallel at the output of the last filter of the multiplier chain. The receive mixer is connected via a small capacitance so that the bandpass filter is not detuned to any degree when the mixer is inactive.

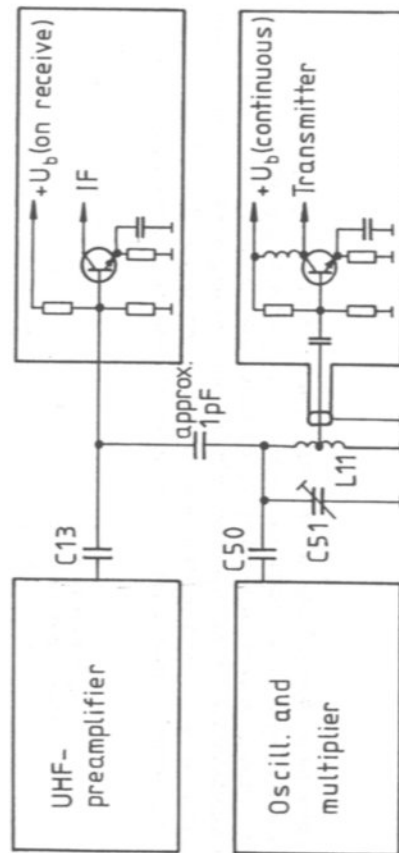

Fig. 8: Connection of the oscillator to transmitter and receiver in the simple version »A«

On the other hand, the transmit input must be matched, especially when it is fed via a coaxial cable. This means that the first stage of the transmitter may not be switched off in the receive mode.

Where minimum size and cost are not the most important criterion, it is recommended that separate oscillator chains be used for transmitter and receiver: the filters can be aligned for more narrow-band operation without sweep measuring system and this results in less loss and higher gain. Since the receive mixer requires less RF power than the transmit amplifier, it is possible for the receive oscillator to be run from less current. The current drain can be reduced to approximately 12 mA including multiplier by using high impedance emitter resistors, whereas the last multiplier of the transmit oscillator requires approximately 7 mA on its own in order to obtain the required power output.

The oscillator in the type B transceiver is equipped with four crystals which can be pulled by at least 100 kHz on the 70 cm band. In order to achieve this, the tuning voltage must be variable between 0 and 8 V. A voltage of 8 V is also required for the stabilized operating voltage for the operating point of the oscillator and multiplier.

If a tuning voltage of 30 V is available, e.g. from a DC-DC converter or from a power supply, it will be possible to double the pulling range of the crystals to 200 kHz. This would mean that each crystal could cover 8 channels of a 25 kHz system. This represents transceiver model C, however, it will be necessary for the cheap varactor diode type BA 138 to be replaced by the more modern type BB 139. The latter type exhibits a higher capacitance variation in the upper voltage range. The tuning curves of both types are given in Figure 9. It will be seen that both curves have a similar steepness at low voltages, but that the BB 139 is more linear.

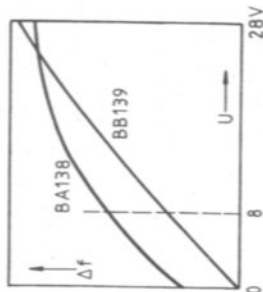

Fig. 9:
Tuning curves
of the varactor diodes
BA 138 and BB 139

An external variable frequency oscillator (VFO) can be connected via connection Pt 6 and a fifth switching diode. If this VFO is able to give an output frequency of 48 MHz, the first multiplier can operate in class A. The oscillator voltage need then only be approximately 0.1 V (RMS). However, if the output frequency of the VFO is in the order of 24 or 16 MHz, it will be necessary for transistor T 9 to also multiply in the VFO mode. In this case, resistor R 42 should be unsoldered from the base; the VFO must then provide a voltage of approximately 1 V.

2.2. UHF Stages

The two UHF preamplifier stages are virtually the same as those of the converter described in (2); however, only a single resonant circuit could be used between the first and second stage since no more room was available. As can be seen in the photograph given in Figure 6, air-spaced striplines are used in order to obtain the highest possible Q so that the image rejection is as high as possible without using metal chambers. For this reason, the simplicity of printed striplines was not used. Furthermore, air-spaced striplines have the advantages that the connection points for the collectors can be shifted as required so that it is easy to obtain the best compromise between gain and selectivity. The antenna matching can also be optimized easily.

The stripline transistors AF 279, and especially AF 279 S are known to have a tendency to self-oscillation due to their high transit frequency. However, if ceramic disc capacitors with thick connection wires are soldered in with very short connections for bypassing the base (multi-layer capacitors are not suitable) and if the circuits are not too loosely coupled, no tendency to oscillation will be observed when using the described construction. In order to reduce this still further, the UHF-preamplifier is operated from a stabilized voltage of 8 V.

4.3. Comparator

4.3.1. Offset-Voltage and Current

It is only the temperature dependence of these parameters that is of interest for the frequency stability. It is assumed that the temperature dependence is $10 \mu\text{V}/^\circ\text{C}$. This value is usually not exceeded even when using inexpensive comparators (operational amplifiers). If 5 V DC-voltage is required at the comparator input to obtain a tuning range of 500 kHz, a voltage variation of $10 \mu\text{V}$ will cause a frequency variation of 1 Hz, corresponding to a relative frequency variation of $0.067 \times 10^{-7}/^\circ\text{C}$.

The temperature dependence caused by the offset current is of the same order.

4.3.2. Effect of the Operating Voltage

$\Delta U_E / \Delta U_B$ is in the order of $50 \mu\text{V}/\text{V}$; this means: an operating voltage variation of 1 V will have the same effect as $50 \mu\text{V}$ input voltage variation. If it is once again assumed that 5 V are required for the tuning range of 500 kHz, the dependence of the operating voltage on the comparator is calculated to be $0.33 \times 10^{-7}/\text{V}$.

4.4. Effect of the Reference Voltage

If the discriminator and reference are fed from the same voltage source, no additional errors will occur in addition to the above, since the variation of the reference voltage will have the same magnitude as the variation of the output voltage of the discriminator. This means that no difference voltage is exhibited at the comparator input.

4.5. Frequency Error of the Control Loop – Residual Error

As was mentioned in the introduction, a frequency error will always be present as residual control error in the case of a frequency control loop.

The frequency control loop can be assumed to be an amplifier with feedback link as shown in Figure 5. As in the case of an amplifier the following relationship exists:

$$fb = \frac{1}{1 + \alpha \times G}$$

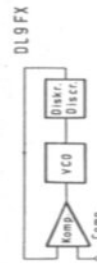

Fig. 5: The frequency control loop
as amplifier with feedback

where fb = feedback factor

where α = fraction of the output voltage used for feedback;

in our case the ratio of the discriminator output voltage to the varactor diode voltage required for a defined tuning of the oscillator.

G = Gain of the comparator without feedback (open loop).

According to (3) the following is valid:

$$U_0 \times f_1 \times t_1 = U_0 \times f_2 \times t_2$$

$$\bar{t}_2 \times f_2 = t_1 \times f_1 = 0$$

$$\text{since } t_1 + t_2 = 1/f_2 \text{ and } \bar{t}_1 = t_1:$$

$$(1/f_2 - t_1) \times f_2 - t_1 \times f_1 = 0$$

$$1 - t_1 \times f_2 - t_1 \times f_1 = 0$$

$$t_1 \times (f_1 + f_2) = 1$$

$$f_1 + f_2 = 1/t_1$$

The sum $f_1 + f_2$ is thus equal to the constants $1/t_1$ and amounts to $1.6 \mu\text{s}$ for 600 kHz. This means that the RC-link at the discriminator determines the frequency shift. In practice, this can be selected within a wide range. The exact position of the reference frequency (crystal frequency) is not critical. Theoretically, it can be between the highest frequency of the lower band and the lowest frequency of the higher band. However, in order to achieve a good lock-in behaviour on switching between these two bands, the reference frequency should be approximately in the center between the upper and lower band.

4. CONSIDERATION OF THE ERRORS

4.1. General

Since the output frequency of the circuit is dependent on the frequency of a fixed (crystal-controlled) frequency and a variable (discriminator), the following considerations are to be made for the maximum discriminator frequency, which is usually the most unfavorable case. In our example it is 500 kHz. In order to obtain some idea of the stability of the output frequency, all values were recalculated for a frequency of 150 MHz. The instability of the reference frequency is not considered. The given values also provide a measure showing how much the values of the frequency control loop are inferior to that of a comparable phase-locked loop.

4.2. Discriminator

4.2.1. Effect of the Operating Voltage

According to the data sheet of the SN 74121 N the variation of the pulse duration amounts to $7 \times 10^{-3}/V$. It is easily possible using modern means to stabilize the 5 V voltage to within 10 mV. Taking this into consideration, the resulting error is a function of the operating voltage and amounts to 35 Hz. This corresponds to a relative error of 2.3×10^{-7} .

4.2.2. Effect of the Temperature

According to the data sheet, a maximum temperature dependence of $1 \times 10^{-4}/C$ is present. The calculated temperature response is thus $3.3 \times 10^{-7}/C$. If the time constants are provided with a certain temperature coefficient, this value can be improved further.

The transistor type 2 N 5179 is used as mixer and in the last tripler. This transistor exhibits a higher transit frequency than the well-known type BF 224. Since the local oscillator frequency is very near to the receive frequency, the bandpass filter after the last multiplier and the resonant line circuit previous to the mixer are virtually as a three-stage filter. Further details are to be given regarding this in the alignment. In order to avoid this coupling, a dual-gate MOSFET was also tried as mixer. However, it required approximately five times the oscillator power due to the higher input capacitance (approx. 8 pF) and due to the higher oscillator voltage required (approx. 1.5 V), which would result in a correspondingly higher current drain.

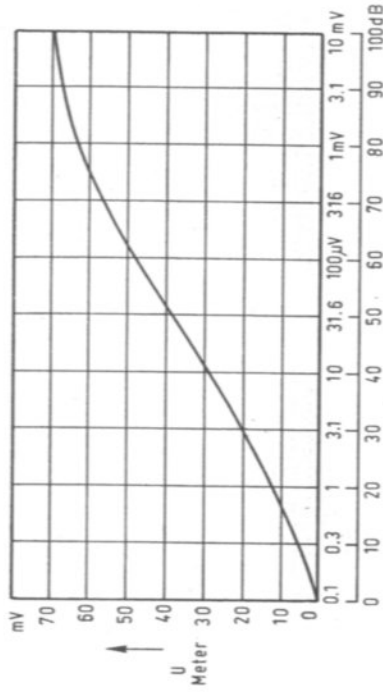

Fig. 10: Calibration curve of the S-meter

2.3. IF Amplifier

No very high demands are placed on the crystal filter. At present, even crystal filters for the 50 kHz spacing (approx. 30 kHz bandwidth) are still satisfactory for 70 cm activity.

The dual-gate MOSFET T 4 works into a very low-impedance resonant circuit (low L/C) in order to keep the gain low. The actual task of this stage is the matching between the high impedance crystal filter (2 kΩ) and the low impedance input of the integrated IF-circuit CA 3089. The automatic gain control via gate 2 is actually not required for FM operation, but it extends the range of the S-meter, without extending the circuitry (see Figure 10).

The integrated ZF circuit CA 3089 possesses a different input circuit than given in (3). It was found that the curves for sensitivity, limiting and operation of the squelch in the manufacturer's data sheet were only valid when the input was terminated with 50 Ω. The wideband noise generated in the IC is so very great already with the termination of several 100 Ω that the IC goes into limiting. In the circuit given in (3), this is compensated for by using a correspondingly high gain previous to the IC, since the limiter amplifier processes the strongest signal. Figure 11 shows the principle of the noise and required signal spectrum for the various operating modes in the form of diagrams.

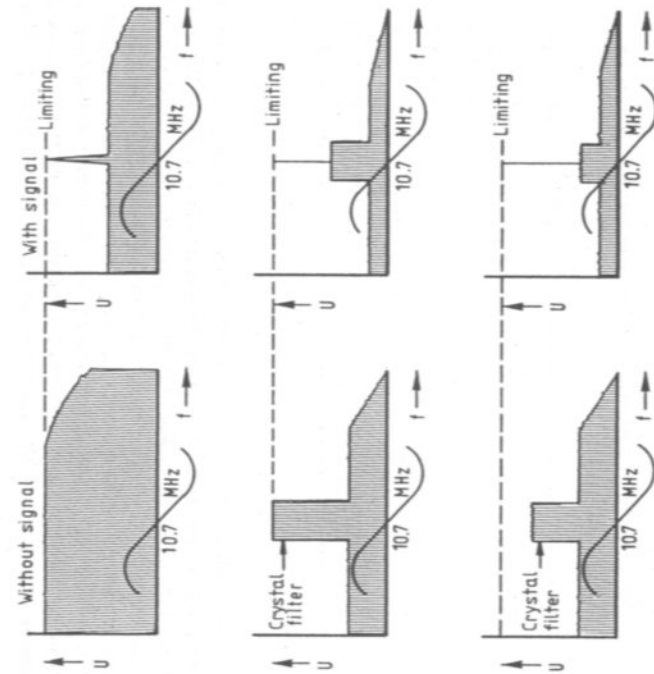

Fig. 11: Noise and required signal in the various operating modes of the CA 3089

The first row shows the operating mode as used in (3) with high impedance input: The noise is limited even without input signal. The greater the signal, the more the noise will be suppressed. By the way, the wideband noise generated in the IC covers the whole frequency spectrum from zero Hz up to the transit frequency of the amplifier.

The noise from the receiver input stages is relatively narrow-band due to the use of the crystal filter. If this noise is amplified so that it is stronger than the intrinsic noise of the IC, it will suppress the wideband noise of the latter as can be seen in the center row of Figure 11. If a signal is also present in addition, the relationship shown in the right-hand drawing of the center row will result. Since the demodulated characteristic is wider than the filter bandwidth, more noise will result at the output in the first case (top row) than in the second (middle).

The noise can be reduced still further when it does not go into limiting (Figure 11, bottom row). In this case, it is possible that AM-interference (ignition interference) will be audible, on the other hand, signals in the noise will also be audible. This is very interesting for amateur radio applications since communication can still be possible, even with repetitions, at signal-to-noise ratios of down to 3 dB, whereas 10 dB is classed as the lower limit for professional communications. As can be seen in Figure 12, the AF output voltage remains practically constant with increasing input voltage, whereas the noise voltage decreases. A signal-to-noise ratio of 20 dB is obtained with an input voltage of 0.7 μ V at 438 MHz. This diagram was measured on a prototype of a 20 unit series, at a frequency deviation of 5 kHz and a modulating frequency of 1 kHz.

2. THE FREQUENCY DISCRIMINATOR

A mono-stable multivibrator (Monoflop) is suitable as discriminator. An example of this is the integrated TTL-circuit type SN 74121. The operation of this IC can be explained with the aid of the pulse diagram given in Figure 2.

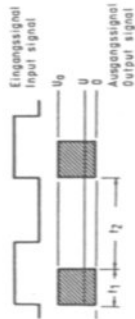

Fig. 2: Pulse diagram of the frequency discriminator

If a pulse is fed to the input, a pulse having a constant length will be provided by the output. The length of the pulse is dependent on the RC-link connected externally.

$$U = U_0 \times \frac{t_1}{t_1 + t_2} \quad (1)$$

$$f = \frac{1}{t_1 + t_2} \quad (2)$$

$$U = U_0 \times f \times t_1 \quad (3)$$

The mean value U of the output voltage is directly proportional to the input frequency, thus the operation is strictly linear. If the reference DC-voltage at the comparator is varied linearly, or in steps, the frequency of the VCO will follow this linearly, or in steps.

3. FREQUENCY SHIFT

The possibility of providing a constant frequency shift of, for instance, 600 kHz for repeater operation, is shown in Figure 3. In this case, the reference frequency is placed between the two required bands. A control loop that has been designed for the lower band (repeater input) can also be made stable for the upper band (repeater output). Since the output frequency lies above the crystal frequency, it is necessary for a phase reversal to be carried out at some position in the control loop. This can be carried out most favorably at the discriminator by switching between output Q and output \bar{Q} (inverted output). The conditions are shown in Figure 4.

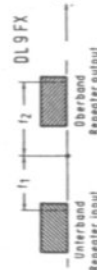

Fig. 3: Possibility of obtaining a constant frequency shift (e.g. 600 kHz)

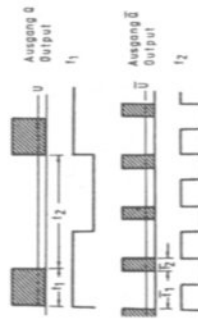

Fig. 4: Relationships at the pulse discriminator on switching from Q to \bar{Q}

THE AFC LOOP

A Simple and Cheap Method of Obtaining Stable VHF Frequencies

by G. Hoffschildt, DL 9 FX

Nowadays, the required local oscillator signal is usually using frequency synthesis or in a PLL-oscillator. A PLL-oscillator is normally preferred due to the better spectral purity of the output signal. Such an oscillator usually operates at the required output frequency (VCO) and uses a phase or frequency control loop. In the case of a phase comparator, the residual error is only a phase error, and the relative accuracy of the output frequency corresponds to that of the referred frequency, if frequency dividers are used in the control system. In the case of a frequency comparator, the residual error will always be a frequency error. For this reason, the frequency control loop is mainly only used in automatic frequency control systems, such as often found in VHF/FM broadcast receivers where an extremely high frequency accuracy is not required. If the control loop is correctly designed and when modern integrated circuits are used, the residual frequency error can be so small that it is more than sufficient for amateur radio applications. There are also a number of interesting possibilities that are not possible when using a phase locked loop: voltage-linear tuning (LMO), generation of any frequency spacing, as well as constant frequency shift for repeater operation. Such a frequency control loop is to be discussed and explained in this article.

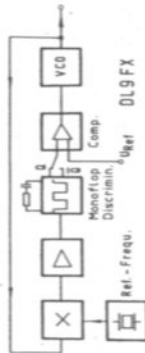

Fig. 1: Block diagram of the frequency-control loop. The potentiometer is used for linear-voltage tuning, a voltage divider connected to UREF is used for generation of a certain frequency spacing.

1. PRINCIPLE OF THE FREQUENCY CONTROL LOOP

The considered frequency control loop should cover a range of approximately 500 kHz in the 2 m band. A block diagram is given in Figure 1.

It will be seen that it is the circuit of a PLL-oscillator. The frequency of the oscillator (VCO) is mixed with a crystal-controlled frequency, and the resulting output frequency fed to a discriminator. This converts the difference frequency to a voltage that is frequency-proportional. This is then fed and filtered in a low-pass filter which is not shown in the diagram. This DC-voltage is fed to a comparator and compared to an external DC-voltage. The output voltage of the comparator is used to tune the oscillator to the nominal frequency.

This means that the output frequency is not only locked to a crystal-controlled frequency, but also to a DC-voltage that can be varied within a relatively wide range. The frequency stability and accuracy that can be obtained are mainly dependent on the characteristics of the discriminator used as frequency-voltage converter.

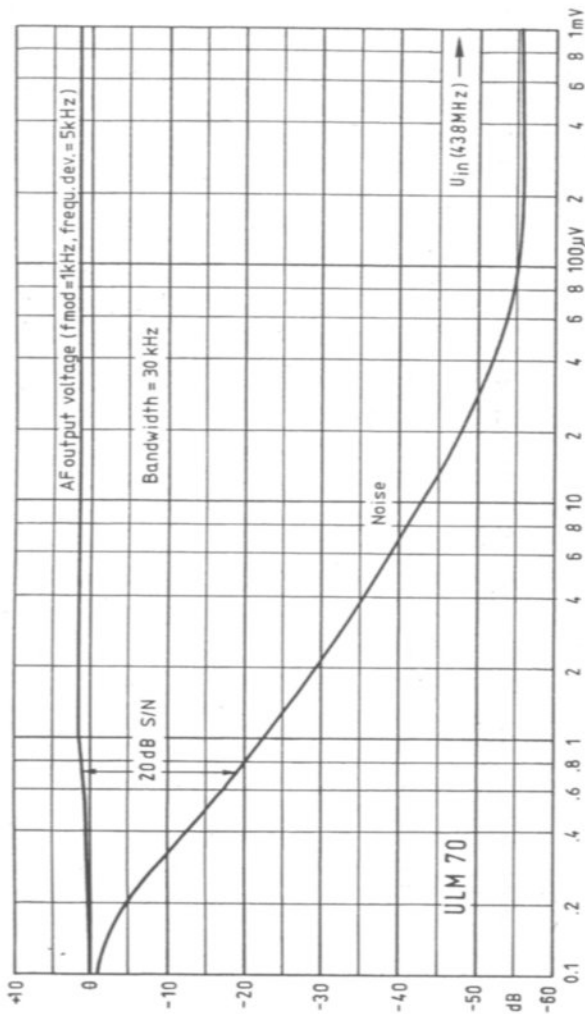

Fig. 12: Signal-to-noise ratio of the receiver

The squeal in the IC CA 3089 evaluates the wideband noise. If, as in the case of the previous circuit, the narrowband noise with the bandwidth of the crystal filter is prevalent, it will not operate correctly. For this reason, a simple circuit equipped with transistor T 6 has been added. This transistor compares the voltage at the S-meter output of the IC (11) with a variable DC-voltage. If no RF-carrier is present, current will flow via transistor T 6, and the AF amplifier in the IC is blocked via connection 5.

A 10.7 MHz crystal can be soldered into place instead of resistor R 25. It then represents a resonant circuit with a high Q and replaces the LC circuit, which still remains in its place. This does not increase the sensitivity but the audio output.

3. COMPONENT DETAILS

- T 1, T 2: AF 279 (S)
- T 3: 2 N 5179
- T 4: 40841 (or 40673)
- T 5: 2 N 2222
- T 6: BC 307, BC 308, BC 213 or BC 415
- T 7: 2 N 5179 or BFY 90
- T 8 - T 10: BF 224 or BF 199
- D 1 - D 5: 1 N 4151 or 1 N 4148
- D 6 - D 9: BA 138 or BB 139
- D 10: 1 N 4151 or 1 N 4148
- D 11: C 9 V 1 - zener diode
- I 1: CA 3089 E without socket

- C 1, C 6, C 12: 5 pF air-spaced trimmer (Tronser) four pins
 C 49: 6 pF ceramic or plastic foil trimmer 7 mm dia.
 C 51: 13 pF ceramic or plastic foil trimmer 7 mm dia.
 C 50: 6 x twisted, L = 6 mm
 C 54: 7 x twisted, L = 7 mm
 C 60: 9 x twisted, L = 9 mm

All capacitors with values up to 0.3 μ F are ceramic disc, bead or multi-layer types. Larger values (1 μ F, 22 μ F) are tantalum drop-type capacitors for 16 V.

- Ch 1: 220 μ H sub-miniature ferrite choke for 10 mm spacing
 Ch 2: 470 μ H sub-miniature ferrite choke for 10 mm spacing

All resistors for 10 mm spacing.

- R 28: 10 k Ω trimmer potentiometer for vertical mounting, spacing 5/2.5 mm
 R 31: approx. 33 k Ω for 100 μ A meter (18 k Ω for 220 μ A-meter)

- L 1, L 3, L 5: 2 mm dia. silver-plated copper wire, 41.5 mm long, bent as shown below
 L 2, L 4, L 6: 1 mm dia. silver-plated copper wire, 38.0 mm long, bent as shown below

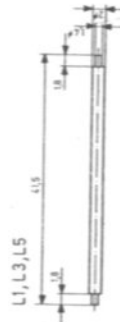

All screened coils are coils as available from the publishers.

- L 7: 20 turns of 0.2 mm enamelled copper wire, red core, (Q = 70) in a screening can of 10 x 10 mm
 L 8: 9 turns of 0.45 enamelled copper wire, blue core, (Q = 40) in screening can of 10 x 10 mm
 L 9: 10 turns of 0.13 silk covered enamelled copper wire
 L = 2.5 μ H, screening can 7.5 x 7.5 mm
 L 10, L 11: 2 turns of 0.8 mm silver-plated copper wire wound on a 3 mm former, self-supporting (bent to fit into the board). Tap on L 10: 1 turn
 L 12: 4 turns of 0.45 mm dia. enamelled copper wire, bright green core, screening can 10 x 10 mm
 L 13: 3.5 turns of 0.45 mm dia. enamelled copper wire, bright green core, screening can 10 x 10 mm
 L 14: 11 turns of 0.3 mm dia. enamelled copper wire, blue core, screening can 10 x 10 mm
 L 15: 10 turns as L 14

Crystal filter: 10.7 MHz, bandwidth 15 to 30 kHz, standard dimensions.

Crystals Q 1 - Q 4: HC-18/U directly soldered into place without socket.

Approximate crystal frequency = input frequency minus 10.7 MHz + 27.

The exact crystal frequency depends on the diodes and the value of capacitor C 73.

4. ALIGNMENT

The oscillator is firstly aligned to 500 Hz \pm 75 Hz by exchanging resistor R 1. After this, a styroflex capacitor of 10 nF \pm 2.5 % (Siemens) should be connected to the input and potentiometer P 1 aligned for full scale in measuring range 3.

This is followed by adjusting the zero points in the two lower ranges with trimmer resistors P 3 and P 2. P 4 should be in a central position. The alignment is then complete.

5. REFERENCES

- (1) Signetics data and application sheet for timer 555
 (2) C. Hall: Direct-reading capacitance meter
 Ham Radio Magazine, Vol. 8 (1975), Edition 4, Pages 32 - 35

MINIATURE VHF-UHF RECEIVERS and Scanners for Both Professional and Amateur Applications

UKW 12 AM

Modulation mode: AM
 Dimensions: 112 mm x 69 mm x 33 mm
 Accessories: Antenna, earphone, battery charger

UKW 2

Modulation mode: FM
 Dimensions: 112 mm x 69 mm x 33 mm
 Accessories: Antenna, earphone, battery charger

UKW 12 FM

Modulation mode: FM
 Dimensions: 112 mm x 69 mm x 33 mm
 Accessories: Antenna, earphone, battery charger

UKW 2

Modulation mode: FM
 Dimensions: 120 mm x 60 mm x 22 mm
 Accessories: Antenna, earphone, battery charger

Features: Possibility of installing two-tone selective call

UKW 4

Modulation mode: FM
 Dimensions: 112 mm x 69 mm x 32 mm
 Accessories: Antenna, earphone, battery charger

UHF 1

Modulation mode: FM
 Dimensions: 120 mm x 60 mm x 22 mm
 Accessories: Antenna, earphone, battery charger

Features: Also available as two-channel receiver. Possibility of installing two-tone selective call.

Sensitivity of the miniature receivers: 0.5 μ V or 1 μ V / 20 dB S/N

Distributor enquiries welcomed.

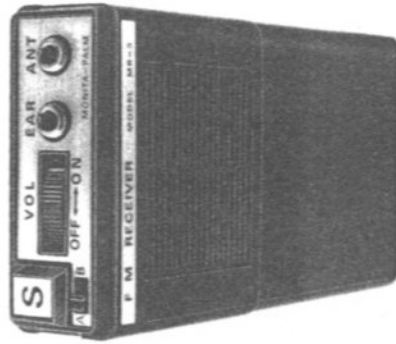

UKW - TECHNIK · Hans Dohlius oHG
D-8523 BAIERSDORF · Jahnstraße 14
Telephone (09133) - 855, 856 · Telex: 629 887

Bank accounts: Postscheck Nürnberg 30 455 - 858
 Commerzbank Erlangen 820-1154

- P 1: 10 k Ω (or 100 k Ω for 100 μ A-meter) trimmer potentiometer, spacing 10/5 mm
- P 2, P 3: 100 Ω trimmer potentiometer, spacing 10/5 mm
- P 4: 5 k Ω potentiometer
- Meter: 100 μ A or 1 mA, 40 mm x 40 mm or 60 mm x 60 mm
- Switch: 2 x 6 change-over switch, 6 mm shaft
- Cabinet: TEKO Ps P 3

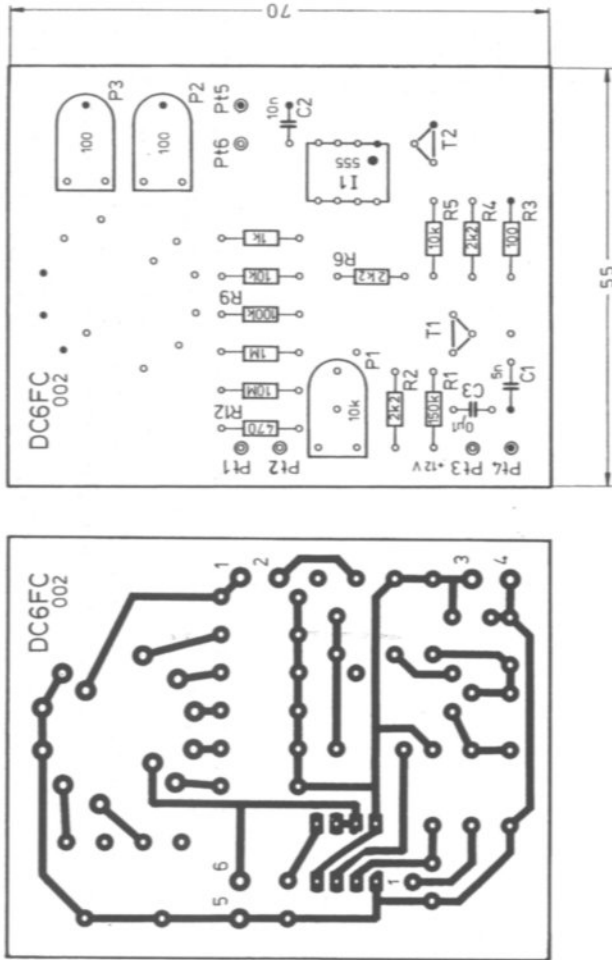

Fig. 4: PC-board DC 6 FC 002 of the capacitance meter

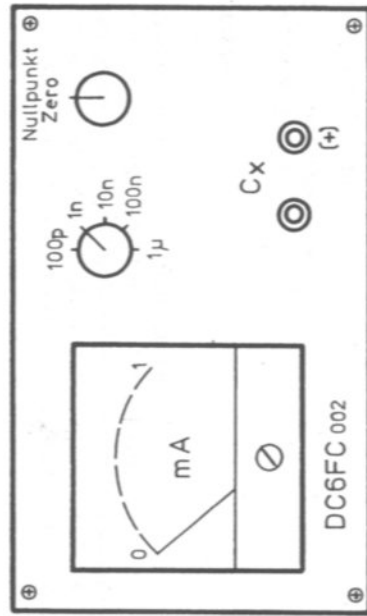

Fig. 5: Front panel of the capacitance meter

4. CONSTRUCTION

The receiver module is accommodated on a 136 mm x 90 mm large double-coated PC-board with through contacts. Figure 13 shows this PC-board with component locations, and Figure 14 the component side. With the exception of the ring-shaped insulated islands, this side remains coated and serves as ground surface. All connection points are on the outer edges. The crystals are soldered into place since the size of the case is not sufficient for using conventional crystal sockets. However, short plug-in collars can be soldered to the PC-board into which the crystals can be placed. The audio output amplifier is to be found on the transmit board since it is combined with the modulator.

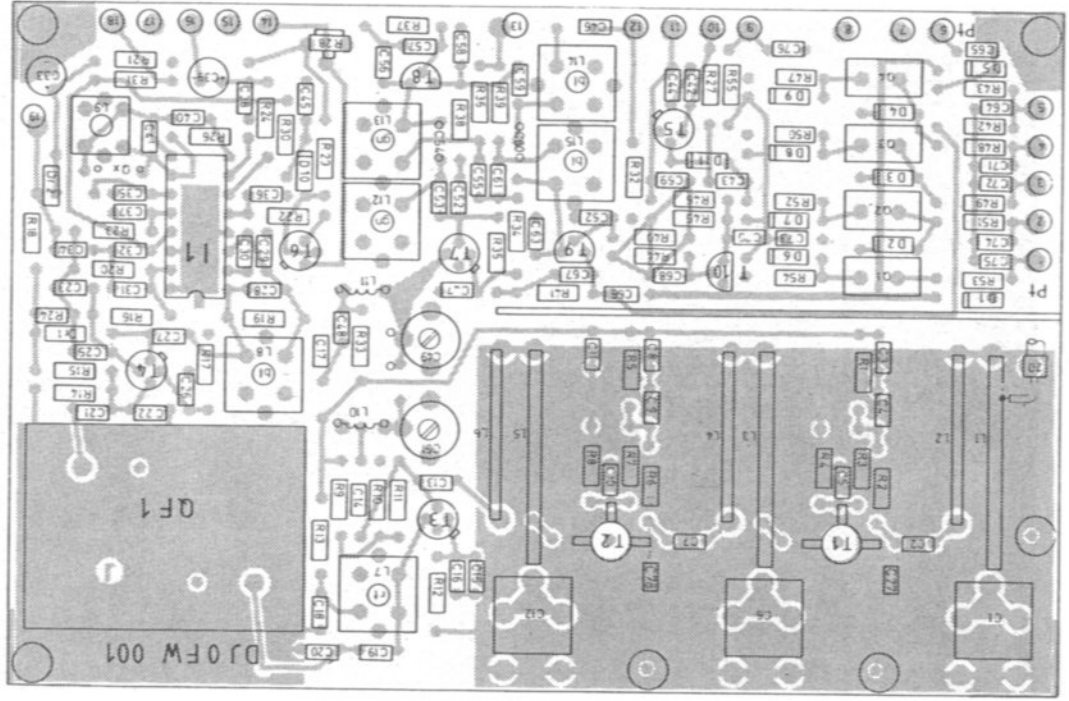

Fig. 13: PC-board DJ 0 FW 001 and component locations

Figure 3 shows the circuit diagram of the complete capacitance meter. A unijunction transistor (T 1) is used as oscillator, which produces narrow pulses with a frequency of approximately 500 Hz. The frequency is dependent on the RC-link R 1 / C 1. Transistor T 2 converts the pulses to trigger pulses suitable for the integrated timer circuit NE 555. The RC-link calculated according to equation (1) consists of the range resistors R 7 to R 11 and the capacitance to be measured, which is connected between connections Pt 5 and Pt 6. The meter having a full-scale deflection of 1 mA integrates the output pulses. Trimmer potentiometer P 1 is provided for alignment of full-scale deflection. Since the circuit possesses an intrinsic capacitance of approximately 25 pF, it is necessary for the zero point to be compensated in the two lowest ranges of 100 pF and 1 nF. This is made electrically using resistors R 12, P 2 and P 3. Potentiometer P 4 is also provided which allows the connection lead capacitances of disc and rotary capacitors to be compensated for in the most sensitive measuring range. This potentiometer is accessible externally.

As can be seen in equation 2a, the operating voltage U_0 and the trigger frequency, or its period duration t_d have an effect on the indication. For this reason it is necessary for them to be stable.

2. SPECIFICATIONS

Operating voltage: 12 V, stabilized
 Operating current: approx. 40 mA
 Measuring ranges (full-scale):
 1. 100 pF
 2. 1 nF
 3. 10 nF
 4. 100 nF
 5. 1 μ F

Smallest capacitance value: approx. 2 pF

3. CONSTRUCTION

The circuit shown in Figure 3 is accommodated on a PC-board having the dimensions 55 mm x 70 mm. Figure 4 shows this single-coated board and the components locations. The board has been designated DC 6 FC 002. The author's prototype is accommodated in a TEKO box together with a small power supply. Figure 5 shows a drawing of the front panel. The larger the meter, the more accurate will be the measured values.

3.1. Component Details

T 1: 2 N 2646 or TIS 43
 T 2: BC 237 or other NPN-AF transistor
 I 1: NE 555 V (Signetics)
 R 7 - R 11: carbon resistors, 1/8 W, 2 %
 C 1: 4.7 nF plastic foil capacitor, spacing 7.5 mm
 C 2, C 3: Ceramic disc capacitors

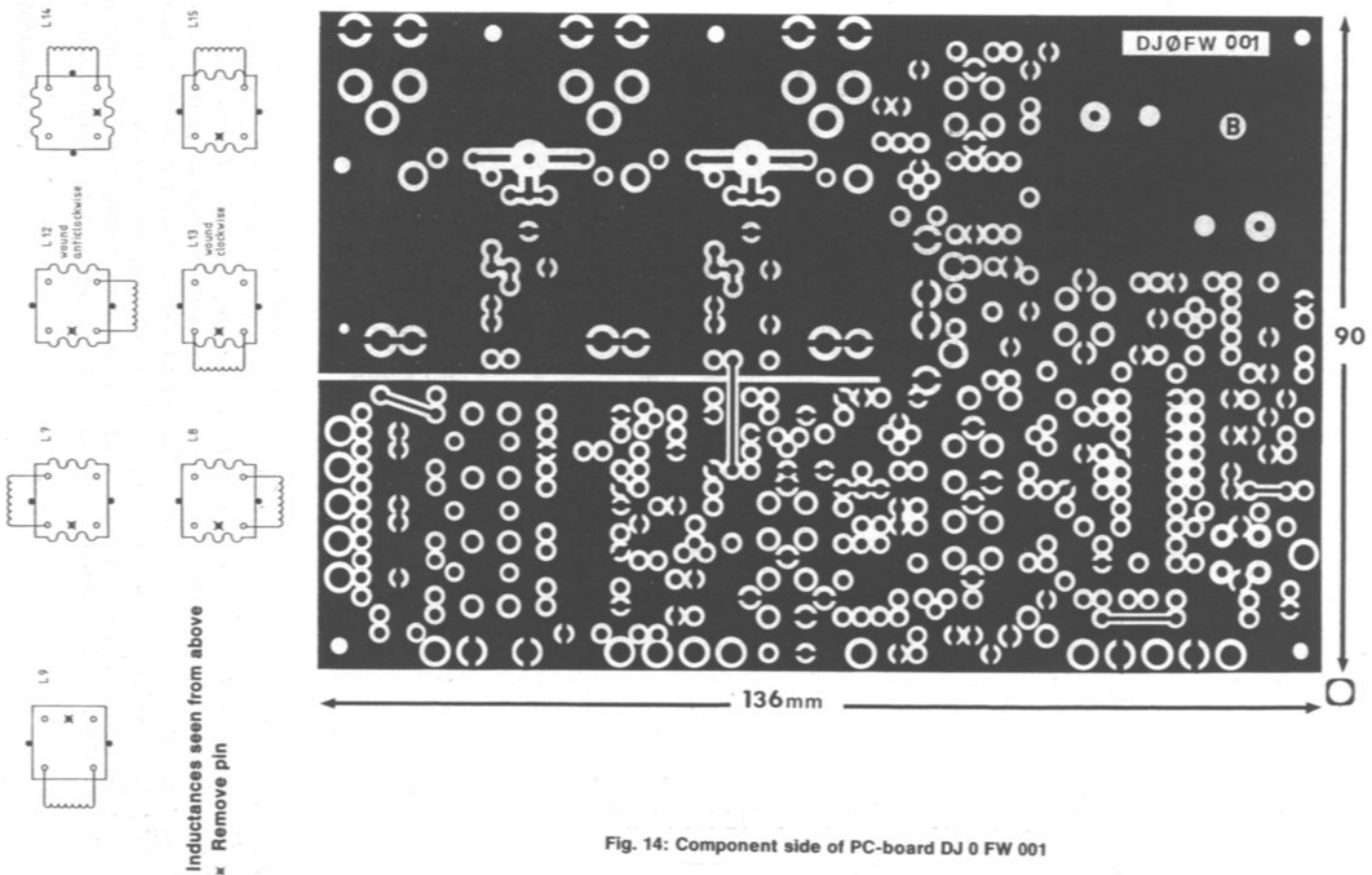

Fig. 14: Component side of PC-board DJ 0 FW 001

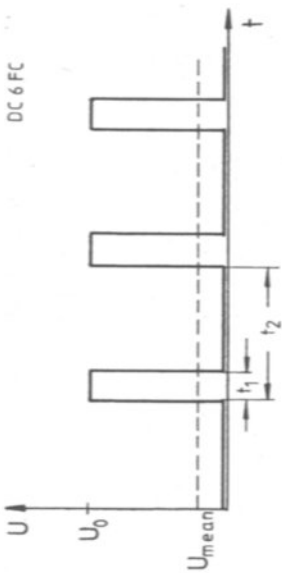

Fig. 2: Output pulses of the Monoflop

If equation (1) is placed into equation (2), the following will be obtained:

$$U_{\text{mean}} = \frac{1.1 \times R \times C \times U_0}{t_2} \quad (2a)$$

This means that the mean value of the voltage resulting from the pulse chain is directly proportional to the capacitance to be measured. The mean voltage is now indicated on a moving coil meter that is able to integrate the pulses. In order to achieve this, it is necessary for the frequency of the trigger oscillator to be sufficiently high: in our case 500 Hz.

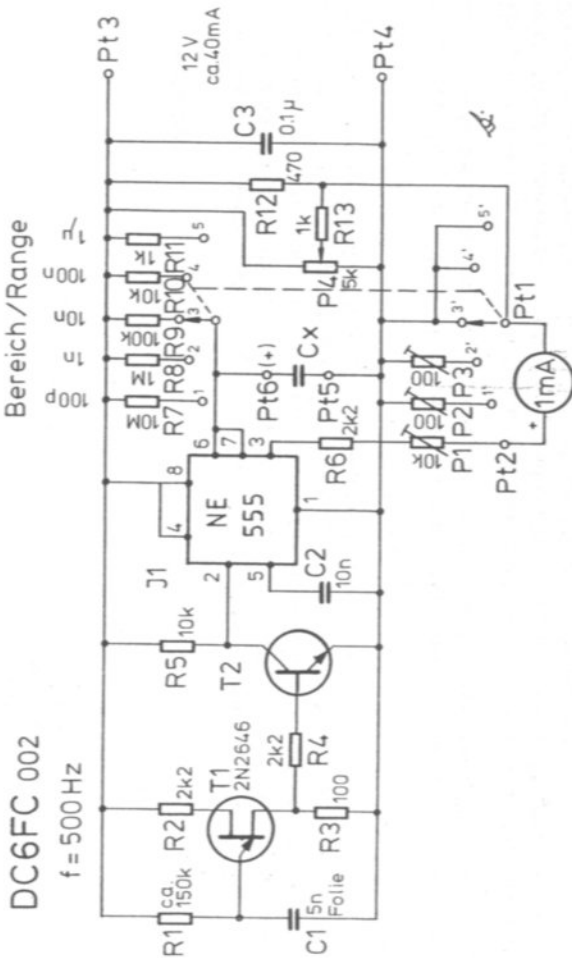

Fig. 3: Capacitance meter for approximately 2 pF to 1 μF

4.1. Crystal Specifications

The nominal frequency f_n of the receiver crystal is calculated as follows:

$$f_n = \frac{\text{Center frequency of the required range} - 10.7 \text{ MHz}}{27}$$

Also give following details: parallel resonance, load 16 pF, HC-18/U.

In order to ensure that the ordered crystal really oscillates at its nominal frequency, it is necessary for the capacitor C 73 to have a certain value according to the varactor diode used. This is C 73 = 68 pF for the BA 138, and C 73 = 33 pF for the BB 139. The oscillator stability and pulling range are practically equal with both capacitance values, however, the output voltage with C 73 = 68 pF is lower than with lower capacitance values. For this reason, the BB 139 is recommended.

Despite of these matching measures, the oscillator frequency will vary by ± 15 kHz referred to the output frequency due to the various tolerances. For this reason, it is necessary that the crystal frequencies of the most important channels are not placed at the edge of the VXO range.

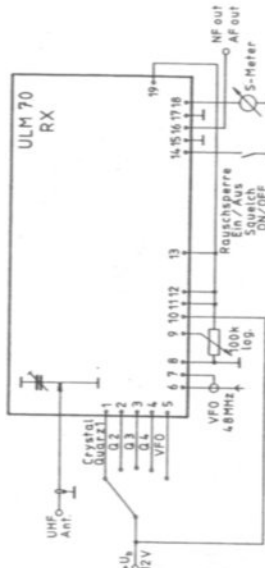

Fig. 15: External connections of the receiver board for alignment

5. ALIGNMENT OF THE RECEIVER

1. Before alignment, check the components and their positions.
2. After this, check all soldered joints and ensure that no short-circuits are made by excessive solder. Remember that any short circuits in the vicinity of the emitter and base connections of transistors T 1 and T 2 will immediately destroy the transistors.
3. The complete board is now connected as shown in **Figure 15**.
4. Connect an operating voltage of + 12 V and measure the overall current. It should amount to approximately 55 mA ± 3 mA.
5. Measure the voltage between connection point Pt 11 and ground: the value should be 8.4 V ± 10 %.
5. The current at one of the switching inputs Pt 1 - Pt 4 should amount to approximately 5 mA independent of the operating voltage, since the base voltage divider is fed with a stabilized voltage. When the crystal for this channel has been soldered into place, the current should increase to approximately 7 mA. Rotate the 100 kΩ potentiometer (frequency tuning) and see whether the current jumps to other values, or whether the oscillation ceases. If so, this would indicate incorrect capacitance values or faulty diodes.

LINEAR CAPACITANCE METER

by R. Reuter, DC 6 PC

This capacitance meter is very simple to construct and is suitable for measuring capacitances in the range between approximately 2 pF and 1 μF with an accuracy of ± 3 %. Even capacitors with a certain polarity can be measured. The scale of the meter need not be changed if a moving coil meter with a full-scale deflection of 100 μA or 1 mA is used, since the capacitance scale is linear. The wiring is kept to a minimum by mounting the range switch directly on the PC-board.

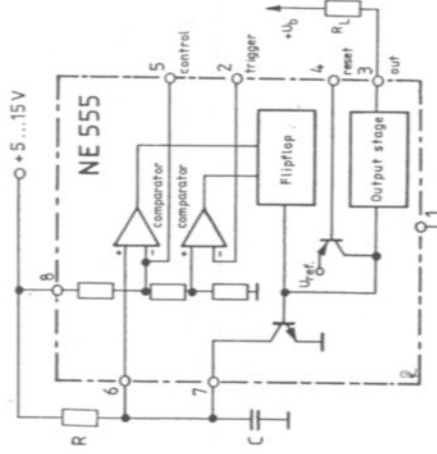

Fig. 1:
The integrated timer circuit
NE 555, with external circuit
for use as Monoflop

1. OPERATION

The capacitance meter is very simple since the critical operating functions are combined in the integrated timer circuit NE 555 (1). Figure 1 shows the operation of this integrated circuit in the form of a block diagram showing the external connections for operation as a monostable multivibrator. The pulses shown in Figure 2 will be generated. The pulse width t_1 is dependent on the RC-link at connections 6 and 7 and is as follows:

$$t_1 = 1.1 \times R \times C \quad (1)$$

In our case, R is a switchable, fixed resistor, and C is the capacitance to be measured. The factor 1.1 is determined by the integrated circuit and can be taken from the data sheet.

The period duration t_2 shown in Figure 2 is dependent on the frequency of the oscillator which triggers connection 2 of the integrated circuit via a pulse shaper. The mean value of the voltage is obtained from the ratio of t_1 / t_2 and the operating voltage U_0 .

The result is:

$$U_{\text{mean}} = t_1 / t_2 \times U_0 \quad (2)$$

5. 7. Measure the voltage drop across resistor R 39 and align inductances L 15 for a dip.
5. 8. Align L 14 for maximum voltage drop across resistor R 36 and align inductance L 13 for a dip.

5. 9. Align inductance L 12 for maximum voltage drop across resistor R 33.

5.10. The voltage drop across the mixer transistor T 3 is measured for alignment of the last bandpass filter comprising L 10 and L 11. The air-spaced trimmer C 12 of the last resonant line circuit is firstly aligned for minimum capacitance. The trimmers C 49 and C 51 of the oscillator filter are aligned for maximum current flow via T 3 (approx. 3 mA). A clear dip in the mixer current (minimum 1.5 mA) will be observed on rotating C 12. The correct alignment is then on the slope of this dip towards the lower capacitance values at approximately 2 mA mixer current.

A 10.7 MHz oscillator is directly connected to the base of the mixer transistor for alignment of the IF amplifier, and the two IF circuits comprising inductances L 7 and L 8 are aligned for maximum S-meter reading. The AF-output is then connected to a low frequency oscilloscope or FET-voltmeter and the demodulator coil L 9 aligned until the demodulator characteristic shown in Figure 16 is obtained when tuning through the crystal filter bandwidth. This tuning is not critical since only a part of the characteristic is used.

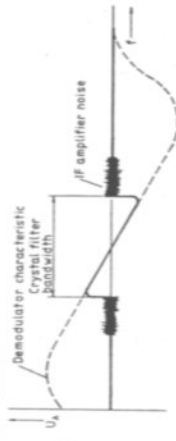

Fig. 16: FM-demodulator characteristics

Finally, a signal generator or a 70 cm antenna is connected and the line circuits comprising the air-spaced trimmers are aligned alternately for best sensitivity.

- 5.11. After completing the alignment, trimmer capacitor C 1, C 6 and C 12 should have approximately the same position. If C 12 differs, this should indicate an incorrect alignment, since this can be aligned to the oscillator frequency. In this case, this trimmer will be in its end position.

- 5.12. Finally, the last bandpass filter of the oscillator chain is aligned with trimmers C 49 and C 51. The highest mixer slope is obtained with the optimum oscillator amplitude, and thus the highest possible gain.

To be continued: part 3 will include the mechanical construction and wiring, and part 4 the transmitter.

6. REFERENCES TO PART 2

- (1) K.P. Timmann: A Variable Frequency Crystal Oscillator (VXO) VHF COMMUNICATIONS 1, Edition 2/1969, Pages 87 - 94
- (2) J. Dahms: Receive Converter 432/28 MHz VHF COMMUNICATIONS 5, Edition 3/1973, Pages 160 - 164
- (3) H.J. Franke: Input Module and FM-Portion VHF COMMUNICATIONS 5, Edition 4/1973, Pages 212 - 219

6.2. Microwave Rectifier and Mixer Diodes

The most suitable type 1 N 23 is available virtually everywhere. The letter following the designation indicates the noise figure and the further the letter is in the alphabet, the lower will be the noise figure. Since the values of the diodes spread considerably, it is recommended that several diodes be purchased in order to select the one having the best characteristics: highest front-to-back ratio, highest diode current, lowest noise. Although they look alike, the diodes type 1 N 21 or 1 N 416 are not suitable since they were constructed for different frequencies.

6.3. Waveguide Components

Professional waveguide components are often to be found on the surplus market. Of course, brass tubing with a rectangular cross-section can also be used, and often represents the most inexpensive solution. However, the dimensions are often different than that of the standardized professional waveguides making combinations difficult.

REFERENCES

- (1) SIEMENS AG: Lineare Schaltungen. Data Book 1976/77
- (2) Dr. D. Evans: Lecture at the VHF-UHF Convention in Munich

To be continued.

SELECTIVE FREQUENCY MULTIPLIERS

by H.J. Brandt, DJ 1 ZB

Frequency multiplication is the oldest method of obtaining stable, variable oscillators and inexpensive crystal oscillators for the VHF band. SSB technology has added the frequency synthesis principle and modern integrated circuits have brought the PLL-oscillator.

The frequency conversion principle is very economical with respect to the current drain and the number of stages required and is suitable for each modulation mode, setting aside the disadvantage of the number of crystals. The number of possible spurious signals is relatively low. They are mainly dependent on the type of frequency synthesis used, and on the filter provided subsequent to the mixer stage.

The PLL method requires a low amount of filtering. However, the current drain can be considerable, especially when TLL or even ECL integrated circuits are used. The spurious rejection is dependent on the frequency response of the control loop and its gain, as well as on the effectiveness of the oscillator buffer stages. If the control loop is broken, or not stable, unwanted emissions can occur within the tuning range of the VCO. This means that a suitable monitoring circuit is necessary.

When using frequency multiplication, the number of possible spurious signals increases together with the frequency multiplication factor. However, if each stage is limited to a doubling or tripling, the relative spacing between the required and the unwanted harmonics is great enough to ensure a good filtering with a minimum of circuits. Thus the spurious rejection of a multiplier chain is not concentrated on a single critical filter, but is spread over the selectivity at the output of each individual stage. These stages can be aligned simply for maximum output at the required frequency with the aid of an absorption wavemeter. This means that frequency multiplication is a very uncritical and clear means of obtaining the required output frequency.

MEMORY KEYS MK 1024

Memory keyer with four independent memories of 256 Bit each. Can be combined to obtain a memory length of 1024 Bit.



- Pushbuttons for selection of memory and start, reset and stop
- Squeeze method or semi-automatic
- Built-in oscillator with variable frequency and volume
- Built-in loudspeaker as well as socket for ext. speaker
- Built-in transistor or relay switching
- Max. switching power: Transistor mode 150 V / 2 A. Relay mode 700 V / 0.5 A.
- Operating voltage 220 - 240 VAC, or 8 - 14 V battery
- Dimensions 140 mm x 60 mm x 165 mm
- Weight 2.3 kg

Dealer enquiries welcome

UKW-TECHNIK
Hans Dohlus OHG
D-8523 Baierdorf, Jahnstr. 14

1. WIDEBAND MULTIPLIERS

Wideband multipliers are virtually unknown to radio amateurs although they can be very interesting for certain applications.

A push-pull rectifier circuit has been well known for a long time (Figure 1); in this circuit, one cycle of the sine-wave voltage is inverted which causes a doubling of the input frequency. If the full bandwidth is not required, the higher harmonic component at the output can be suppressed with the aid of capacitor C. The passive doublers offered by many manufacturers for extending the frequency range of their signal generators operate according to this principle. Their dimensions are often only half the size of a matchbox.

Linear integrated circuits have been available on the market for some time now that allow a doubling of the frequency by quartering the input signal (Figure 2). This theory is based on the formula $\cos^2 \omega t = 1/2 (1 + \cos^2 \omega t)$. This means that when a cosine function is quartered, a constant value (DC) and a cosine function with twice the frequency is generated. The circuit should not be overdriven in order to ensure a good output waveform. With some types, it is recommended that an external balancing be made.

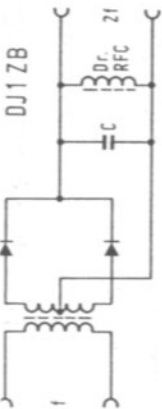

Fig. 1:
Push-pull rectifier
as frequency doubler



Fig. 2:
An integrated quarterer
as frequency doubler

The input signal of these wideband doublers should be as sinusoidal as possible. However, the author's experience has shown that the spurious rejection is not better than 25 to 30 dB. This means that additional selectivity in the subsequent stages must be provided.

2. SELECTIVE MULTIPLIERS

2.1. Use of Bipolar Transistors

If the available signal is not large enough to open a blocked transistor, it will be necessary to use a multiplier operating with a certain quiescent current. Figure 3 shows a suitable circuit. The circuit seems similar to a conventional A-amplifier, however, the emitter resistor is selected so high that the collector alternating current will become greater than the collector DC-current under drive conditions. The DC-voltage is kept constant due to the base voltage divider. However, the DC-voltage at the emitter resistor increases, which means that the operating point of the transmitter is shifted from class A to class B or even class C by the drive. The emitter bypass capacitor maintains the DC-voltage during currentless conditions. Under these conditions, the same clipped sine-wave curve will be exhibited as was shown in older manuals with respect to class C amplifiers and multipliers equipped with tubes. The current flow angle can be adjusted using the emitter resistor R_E so that the circuit can be optimized for doubling or tripling.

The DC-voltage values given in Figure 3 are orientation values for the design of the base voltage divider in order to ensure a good temperature stability. A resistor of 10 to 100 Ω is connected between collector and resonant circuit in order to suppress any tendency to parametric oscillation.

5. A SIMPLE TRANSCIEVER

The described Gunn oscillator allows an extremely simple transceiver to be constructed. For this, the oscillator is directly mounted to a horn antenna and connected to the modulating and operating voltages. This represents the complete transmitter. In the receive mode, the Gunn element is used as self-excited mixer and the frequency to be received is mixed with the Gunn oscillator frequency. The resulting intermediate frequency is then fed to a portable or car radio that has been adjusted to approximately 104 MHz. This receiver is used as IF amplifier and demodulator. Figure 22 shows the principle of operation.

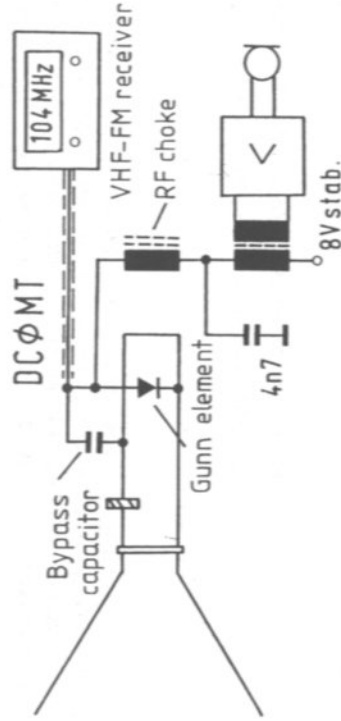

Fig. 22: A simple 10 GHz transceiver

If the partner station has such a system, it is possible for duplex operation to be made, and one will be able to monitor one's own modulation in the receiver. The transmit frequencies of the two stations must differ to the amount of the intermediate frequency, e.g. 104 MHz.

Since the Gunn element is not an ideal mixer, the sensitivity of the system is not very good; the noise figure is in the order of > 25 dB. In spite of this, radio communication can be made over distances of more than 10 km, and regular communications take place over distances of more than 100 km.

6. AVAILABILITY OF MICROWAVE COMPONENTS

6.1. Gunn Diodes

In addition to the well-known Plessey diodes, there are a number of diodes manufactured by other manufacturers that are available inexpensively. NEC manufactures diodes for 30 mW and 60 mW (designation: ND 7, X-band, center frequency 10 GHz, 30 mW; ND 7, X-band, center frequency 10 GHz, 60 mW). Also type DGB 6844 A, 15 mW X-band, and type DGB 6835 C, 50 mW, X-band. Philips manufactures type CX Y 11 C, X-band, 15 mW.

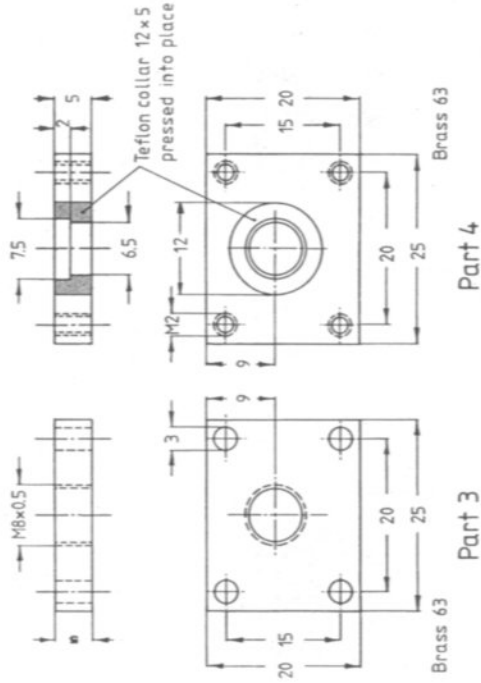

Fig. 20a: Diode holder of the probe

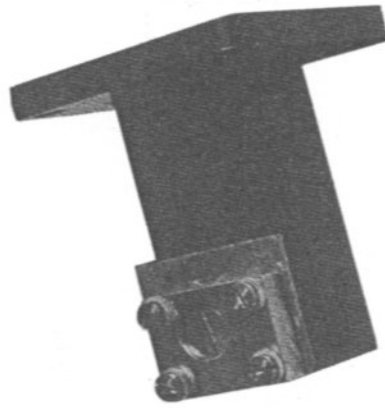

Fig. 21: Photograph of the diode probe

The oscillation is firstly checked by screwing the Gunn oscillator and diode probe together. At RF output powers in excess of 10 mW, it will be necessary for an attenuator to be connected between them, otherwise the diode of the probe will be destroyed. If an indication is shown on the meter on switching on the oscillator, this will indicate that the oscillator is operative. The bias voltage is now adjusted for maximum output power from the oscillator. The short-circuit piston is now adjusted for maximum power. This position should be marked, the piston should be removed and a short-circuit panel should be soldered into place at this position. If the dimensions of the resonator have been maintained exactly, one can be assured that the oscillator is operative in the correct frequency range. A wavemeter is to be described in the next part of this article that allows the operating frequency to be checked during operation.

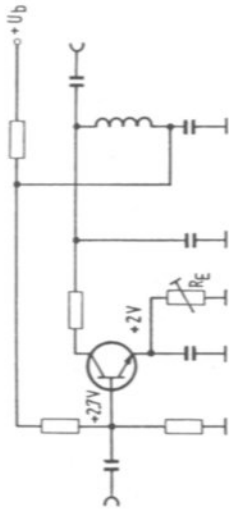

Fig. 3: Frequency multiplier with quiescent current for use with weak drive signals

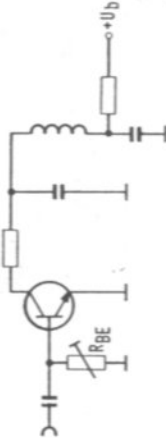

Fig. 4: Frequency multiplier stage in class C

If sufficient drive is available, the previously described base voltage divider can be deleted and the optimum operating point adjusted with the aid of the lower resistor and emitter resistor. This saves a number of components and results in the circuit given in Figure 4 which no longer requires an emitter resistor and the operating point is adjusted with the base-emitter resistor R_{BE} . A negative voltage of 0.4 to 1 V is generated across this resistor under drive conditions due to the base current. This can easily be measured using a high-impedance voltmeter by placing a low-capacitance RF choke in front of the probe. The value of resistor R_{BE} for a certain operating point is, of course, dependent on the transistor. The collector circuit is connected as was shown for Figure 3.

Figure 5 shows the relationship between the resistance value of R_E or R_{BE} and the output voltage or output power of the multiplier. The most favorable value is determined with the aid of a trimmer potentiometer and the next highest value of the fixed resistor is then used in the circuit. A value below this optimum point could lead to a deterioration of the multiplier efficiency due to tolerances and temperature effects.

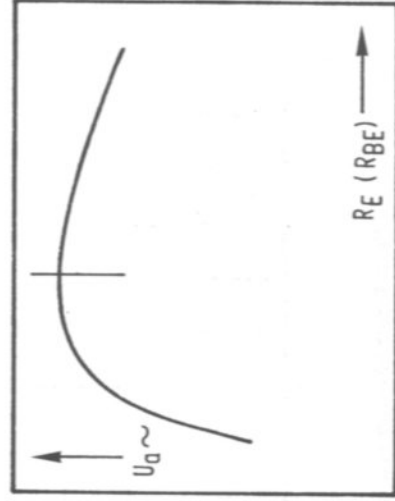

Fig. 5

2.2. Selective Multiplier equipped with a Field Effect Transistor

Figure 6 shows the circuit of a multiplier designed by DC 1 MK using a junction field effect transistor. This circuit operates with a certain quiescent current and is therefore suitable for multiplication of low RF voltages. The N-channel FET generates a negative bias voltage across the resistor R_g . It should be possible to optimize the operating point by alignment of R_g , however, this was not tried by DC 1 MK.

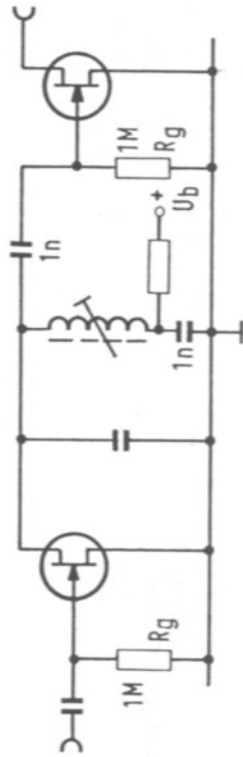

Fig. 6: Selective frequency multiplier equipped with field effect transistor

3. SPURIOUS REJECTION AS A FUNCTION OF THE PROVIDED SELECTIVITY

Figure 7 shows the basic spectral display of the output signal of a multiplier chain. Several lines will be seen on both sides of the required frequency f , each of different amplitude. Their spacing corresponds to the input frequency of the multiplier chain.

This spectrum is generated, for instance, when a 18 MHz signal is doubled to 36 MHz, and the 18 MHz component is not completely suppressed. The next doubler then receives a 36 MHz signal that is modulated with the 18 MHz signal and thus generates a 72 MHz signal that is in turn modulated with 18 MHz, and if the selectivity is not sufficient also at 36 MHz. The next doubler then generates the required frequency of 144 MHz, which is modulated in turn with 18 MHz, 36 MHz and 72 MHz components. In addition to this, the harmonics of 144 MHz are also present in the output signal.

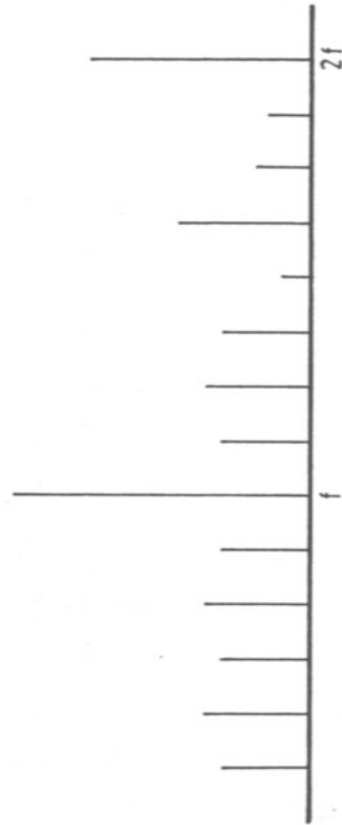
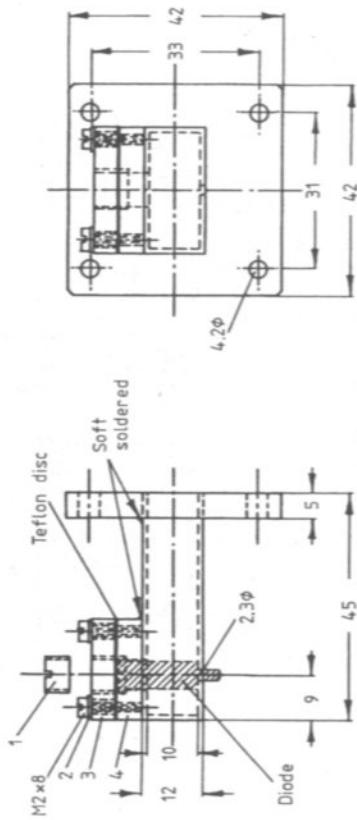

Fig. 7: Output spectrum of a frequency multiplier chain

further. The required operating point is to be found just before maximum current. A simple diode probe can be used to check to see whether oscillation takes place. This diode probe is required later as mixer. The microwave diode (such as type 1 N 23) is placed in the center of the waveguide. One pole is connected via a bypass capacitor to a meter. Figures 20 and 21 give details of such a probe that can be very useful for adjustment of Gunn oscillators.



Material: brass 63

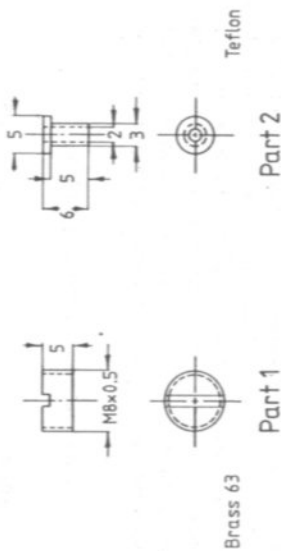
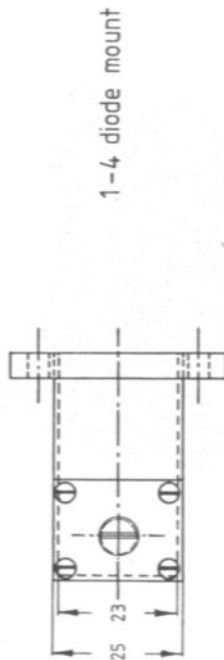

Fig. 20: Diode probe

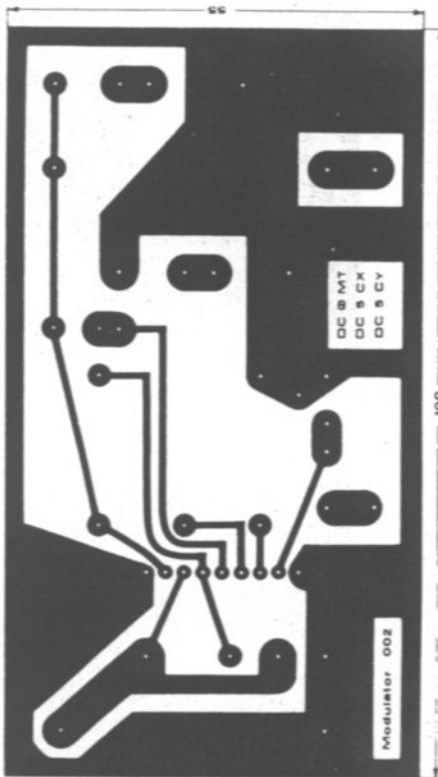

Fig. 18: PC-board DC 0 MT 002

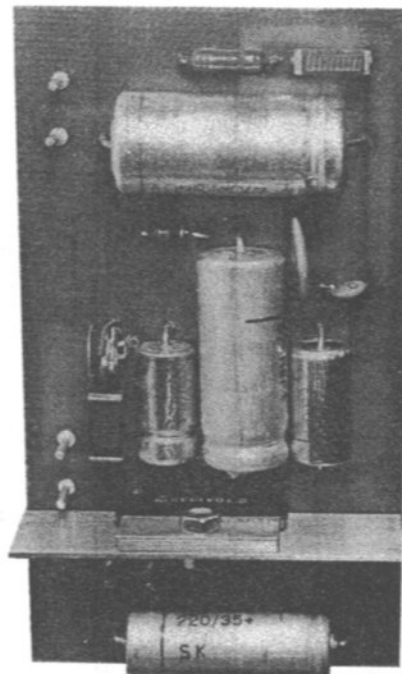

Fig. 19: Photograph of the modulator DC 0 MT 002

4. PREPARATIONS

Before switching on, it is very important to see whether the Gunn diode is correctly placed into the holder, since the wrong polarity will destroy the element. The operating voltage is firstly adjusted to the lowest value (approx. 6 to 7 V). Since the current drain values of various Gunn diodes fluctuate greatly, no orientation value can be given for the current drain. However, it should not be more than 100 mA in the case of 5 mW elements. If the voltage is then carefully increased, the current will firstly rise, but will then fall on increasing the voltage

The German Post Office lays down a maximum spurious output of 25 μ W for amateur radio transmitters with operating frequencies of over 30 MHz and up to 25 W output power. At higher output power levels, the spurious rejection of at least 60 dB is required. For the radio amateur with limited measuring facilities, it is very interesting to know what amount of filtering is required in order to achieve a spurious and harmonic signal rejection of 60 dB.

The author and DC 2 CV have worked together to gain experience with multiplier chains for several projects. A spectrum analyzer for frequencies up to 1200 MHz and a dynamic range of 70 dB was available for the spurious signal measurements. The results are now to be described.

3.1. Frequency Doubler with Single Resonant Circuit

The first measurements were made on a frequency doubler chain with a single resonant circuit at the output of each stage. The construction was made as described by DC 1 MK and equipped with FET doublers similar to that shown in Figure 6. This circuit was then followed by a power amplifier (see Figure 8). The spurious signal rejection amounted to an average of 43 dB. In order to obtain better results, several circuits were built using, if possible, inexpensive bipolar transistors.

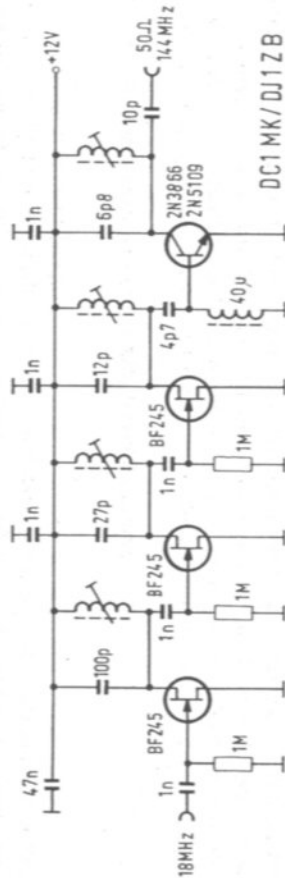

Fig. 8: FET frequency multiplier chain with series resonant circuits

3.2. Frequency Doubler with Parallel and Series Circuits

Figure 9 shows a frequency multiplier chain using the circuits shown in Figures 3 and 4. However, in order to increase the selectivity, the output signal is fed to the subsequent stage via a series resonant circuit. This arrangement has the advantage that the matching between both stages can be aligned continuously using two inductances.

However, measurement of the spurious signal rejection was very disappointing. The results were not better than that of the circuit shown in Figure 8. Attempts were made to increase the selectivity of the parallel circuits using higher capacitance, and the series circuits by using lower capacitance. The output power was noticeably reduced, but there was no noticeable effect on the spurious rejection. The values given in Figure 9 correspond to the final result.

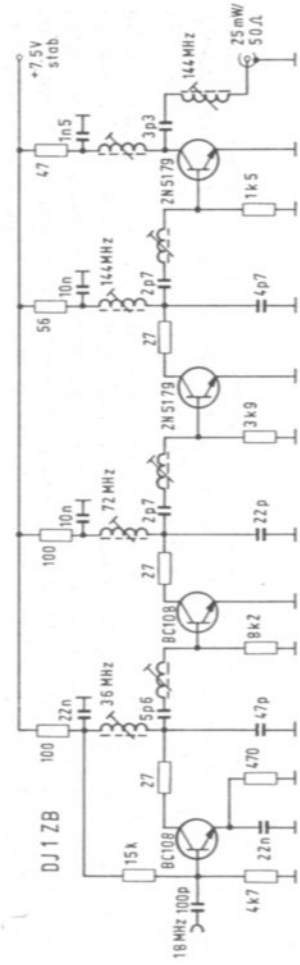

Fig. 9: Frequency multiplier chain with parallel and series resonant circuits

On examining the spurious rejection at the base of the second doubler, it was found that a very strong component of the input frequency (18 MHz) was still present. It seems that the combination of parallel and series resonant circuits was not able to suppress the input frequency of the doubler sufficiently.

3.3. Frequency Multiplier with Two-Stage Bandpass Filter

In the meantime, DC 2 CV had constructed a frequency multiplier chain from 24 MHz to 144 MHz using two stages similar to that shown in Figure 3. A capacitively coupled two-stage bandpass filter is used for selectivity. The inductances are enclosed in individual screened cans which are screwed on to a copper coated ground surface, which serves as ground for the whole circuit. The spurious rejection of over 60 dB was achieved using this construction.

After this success, the author also modified the first two doublers of his circuit for bandpass filter coupling (Figure 10). Although the inductances were unscreened and were mounted simply on a copper-coated board, and although the ground conditions were most certainly not so ideal as DC 2 CV's construction, a spurious rejection of over 60 dB was also measured.

Figure 11 shows the basic installation of the multiplier chain in a TEKO box type 4 A. The 16 MHz crystal and associated trimmer are mounted in the bottom left-hand corner. A VXO and voltage stabilizer circuit for 7.5 V are mounted beside this. The designations V_1 to V_p show the position of the transistors when the circuit shown in Figure 10 is used. The position of the inductances is given in the form of circles. The ground surface runs around the edge of the board including the VXO.

With this author's prototype, the last doubler was not modified for bandpass filter coupling so that the board did not need to be modified. Due to this, the 72 MHz components were stronger than necessary in the output signal spectrum. However, this was not too important since they will be suppressed by the 2 m bandpass filter (1) at the output of the transmitter. Bandpass filter coupling will be used for all frequency doubler stages for future constructions.

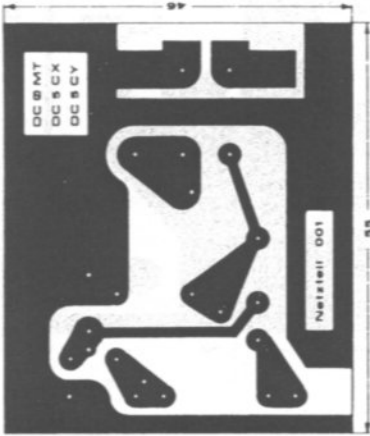

Fig. 15: PC-board DC 0 MT 001

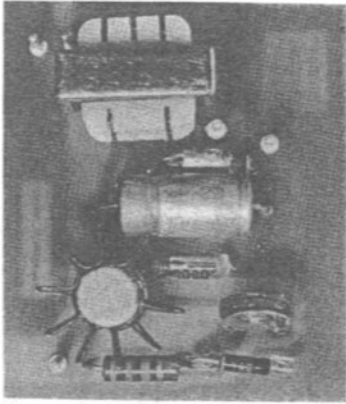

Fig. 16: PC-board DC 0 MT 001

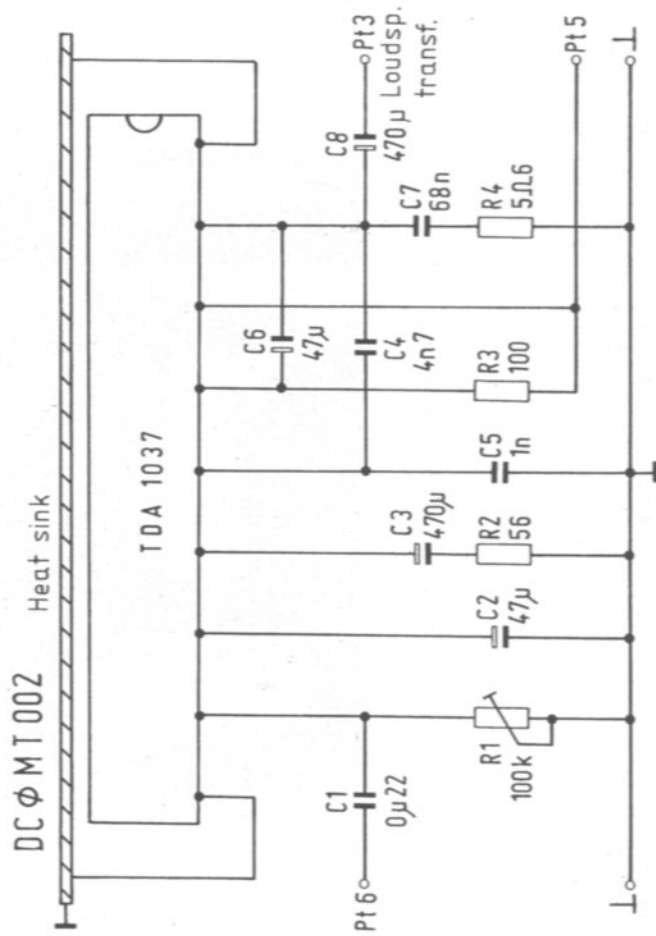

Fig. 17: Modulator circuit DC 0 MT 002

capacitor, whose dielectric is a thin plastic foil; PTFE (Teflon) is recommended. Since the Gunn element can oscillate together with any inductance, external inductances are very dangerous, since parasitic oscillation can occur at considerably lower frequencies, which could then destroy the element. For this reason, the oscillator should be bypassed with low-inductive disc capacitors directly adjacent to the oscillator.

3. POWER SUPPLY AND MODULATION

According to the manufacturer, and the power rating, Gunn elements require operating voltages in the order of 7 V to 10 V. This voltage should be stabilized since any variation of the operating voltage will cause fluctuations of the output frequency. If a battery voltage of 12 V is available, a simple stabilizer circuit comprising a pass transistor and zener diode will be sufficient. The operating current drain flowing through the Gunn element amounts to a maximum of 500 mA at an RF power of 50 mW. If one is satisfied with an output power of 5 mW which is sufficient for communications even over greater distances, the current drain will only be approximately 200 mA. A suitable stabilizer circuit is given in **Figure 14**.

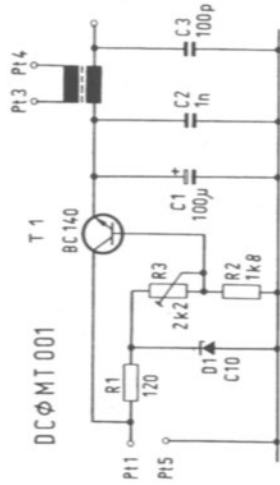

Fig. 14: Power supply and modulating transformer

The fact that small voltage variations at the Gunn diode cause frequency variations means that it is possible to use this for frequency modulation. The supply voltage is thus fed via the secondary winding of a transformer and the primary side is connected to the modulator.

A frequency deviation of more than 50 kHz will be obtained with a modulating voltage of approximately 0.2 V.

A loudspeaker transformer from an old transistor radio can be used as modulating transformer. The low-impedance winding (loudspeaker connection) is connected to the modulator. The operating voltage of the oscillator is fed via the high-impedance winding. This circuit allows a clean and clear modulation, whose quality is considerably better than when using an operational amplifier. **Figure 17** shows the circuit of a suitable modulator which is able to completely drive even the higher-powered Gunn elements. The new integrated amplifier TDA 1037 allows an extremely simple construction; normal dynamic microphones can be used.

It is necessary for the modulating cable to be grounded with respect to RF voltages in order to avoid parasitic oscillation. In order to ensure that the bypass capacitor does not short out the higher modulating frequencies, its capacitance should not be greater than 4.7 pF. This capacitor should be mounted as near to the oscillator connection as possible.

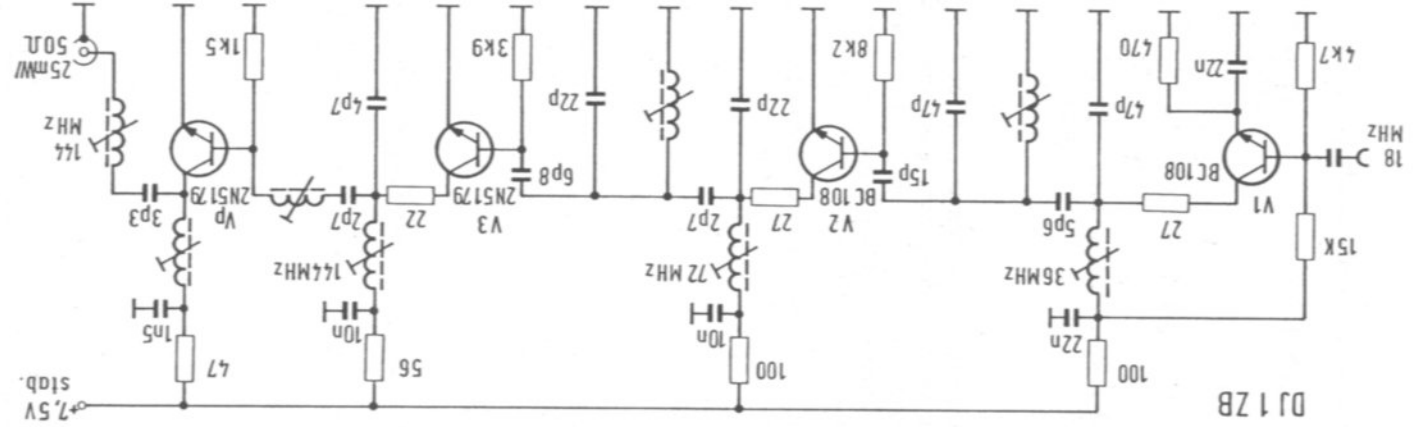

Fig. 10: Frequency multiplier chain with capacitively coupled two-stage band pass filters

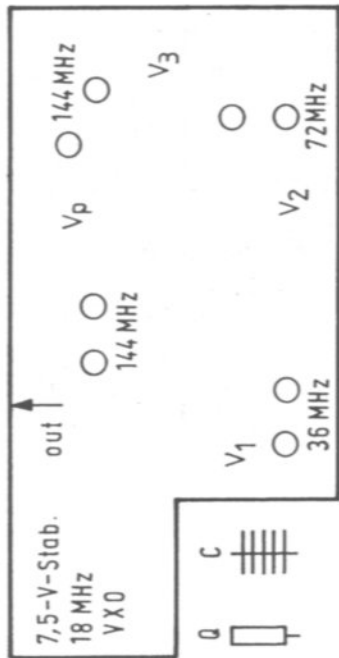

Fig. 11: Basic arrangement of the frequency multiplier chain in a TEKO box

If one compares the filter circuits of Figures 9 and 10, it will be seen that only two extra capacitors are actually required. However, the circuit of the second bandpass filter stage with its capacitive input and output coupling is far more suitable for suppressing frequencies below the required harmonic than a series resonant circuit. The good result obtained using these bandpass filters shows how important it is to suppress the input frequency of the frequency multiplier stage in order to obtain a good spurious rejection.

In order to simplify the design of the bandpass filter for any required frequency, Figure 12 shows a frequency-independent diagram where the capacitance values are not given but their reactive impedance. The required values for the application in question can be calculated from these values. The inductances should be designed for resonance. This circuit is valid for operating voltages in the order of 10 V and for currents of approximately 5 mA.

A capacitive current divider circuit is used for coupling the subsequent bipolar transistor onto the second bandpass filter circuit. This means that a part of the resonant circuit current is tapped off and flows through the transistor input. This leads to lower capacitance value than will be present with the capacitive voltage divider and the lower capacitance can be very large under some conditions and possesses a considerable intrinsic inductance.

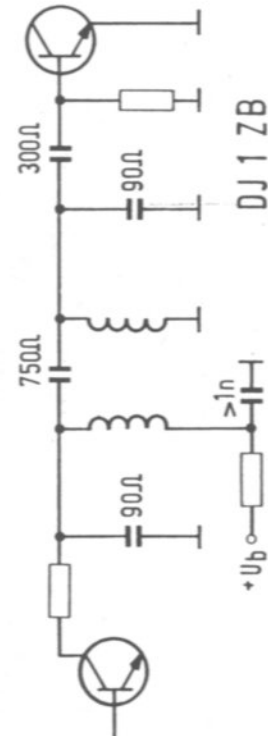

Fig. 12: Frequency-independent circuit to simplify calculation of designed criterion

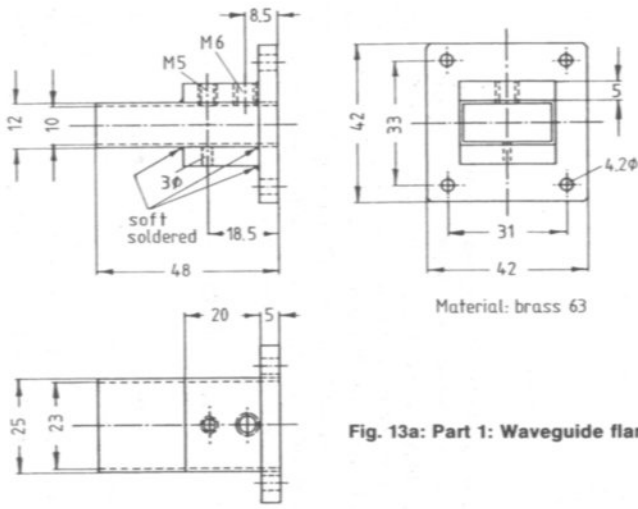

Fig. 13a: Part 1: Waveguide flange

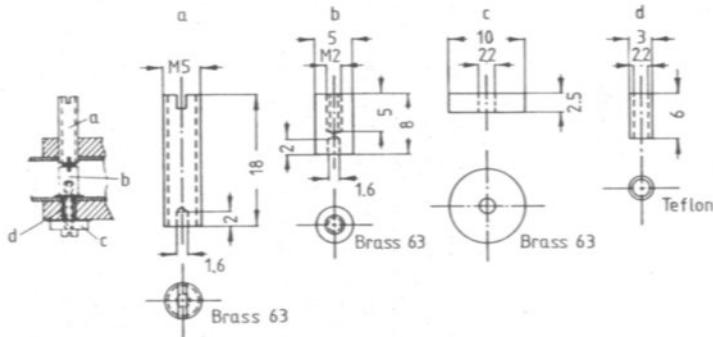

Fig. 13b: Part 2: Diode mount

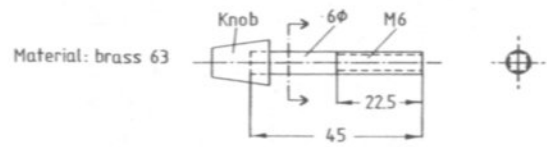

Fig. 13c: Part 3: Tuning pin

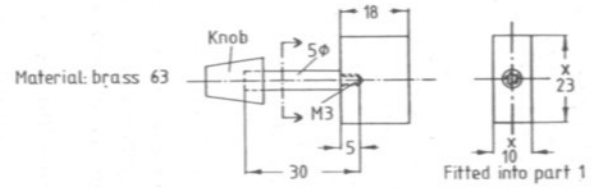

Fig. 13d: Part 4: Short-circuit piston

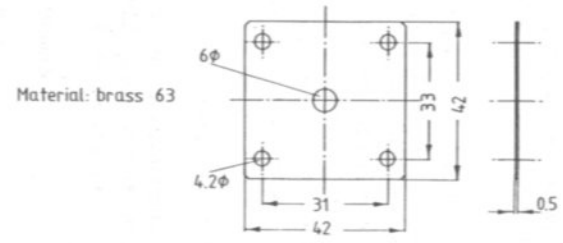

Fig. 13e: Part 5: Iris

cavity resonator has a length of one complete wavelength. The frequency-determining length is now the spacing between the panel and Gunn element. In practice, it has been found that it is advisable to keep this distance somewhat smaller than given in Figure 12.

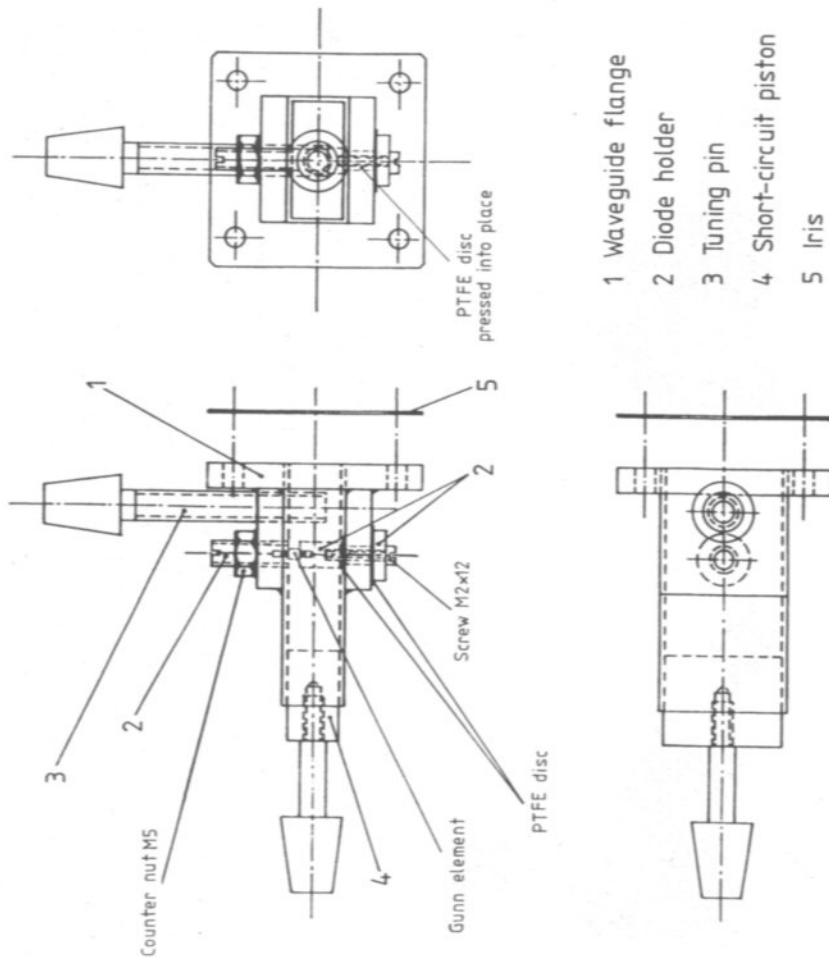

Fig. 13: Gunn oscillator and construction

The frequency is then somewhat too high and the required frequency can be adjusted using 0.5 mm or 1 mm thick brass spacers between the flange and iris. These spacers must have the same shape as the flange. If the frequency is too low, a correction is virtually impossible with normal means. In this type of construction, the short-circuit piston has little effect on the frequency of oscillation, but has a great effect on the output power. For practical operation later, it is better that the piston be replaced by a fixed short-circuit panel at the correct position.

The following is important for mounting the Gunn element: One connection is grounded, normally the minus pole; the other connection must be connected to the external operating voltage. This is usually fed in in the form of a bypass

4. DISADVANTAGES OF TOO LOW A COMMENCEMENT FREQUENCY

To finalize, the disadvantages of using too low a commencement frequency for the frequency multiplier chain are to be discussed. When using inexpensive 9 MHz crystals, the first spurious line above 144 MHz falls into the business radio band and can be sufficiently strong to cause interference to neighbouring business radio systems. A few individual cases of this have been known when using an intermediate frequency of 10.7 MHz. It may be good practice to use even a three-stage filter for the first frequency multiplier in order to suppress the adjacent spurious lines.

A further disadvantage of using a commencement frequency of 9 MHz was found when constructing the 70 cm repeater DB 0 TR in Rosenheim. Since the spacing between transmit and receive frequencies using the European standard amounts to 8.5 MHz, the first spurious line 9 MHz below the transmit frequency overloaded the receive converter. This problem was solved by modifying the frequency multiplier chain for a commencement frequency of 18 MHz.

5. REFERENCES

- (1) H.J. Brandt: A Simple Bandpass Filter for the 2 m Band VHF COMMUNICATIONS

LINEAR AMPLIFIERS for 2 m and 70 cm

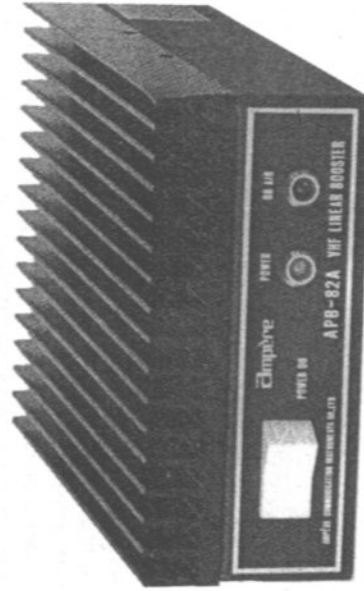

Clean linear operation due to optimum biasing and use of CTC transistors BM 70-12 or CM 40-12 resp.

Band	145 MHz 432 MHz
Output	80 W 40 W
Input	10 W 10 W
Current	10 A 6 A
Size (mm)	130 x 58 x 200

Dealers enquiries welcome to
UKW-TECHNIK · Jahnstr.14
 D-8523 Baiersdorf(W.Germany)

UKW - TECHNIK · Hans Dohlius oHG
D-8523 BAIERSDORF · Jahnstraße 14
Telephone (09133) - 855, 856 · Telex: 629 887

Bank accounts: Postscheck Nürnberg 30 455 - 858.
 Commerzbank Erlangen 820-1154

A SIMPLE BANDPASS FILTER FOR THE 70 cm BAND

by H.J. Brandt, DJ 1 ZB

1. INTRODUCTION

This filter operates according to the same principle as the 2 m bandpass filter described in (1). Since the dimensions of the case are considerably more favorable for the 70 cm band, better filter characteristics than the 2 m version were to be expected. However, this is not completely true in practice.

1.1. Location of the Connectors

It was found when constructing the first prototype that it was not possible for the connectors to be placed anywhere required, if reproducible characteristics are to be obtained. Furthermore, the narrow sides of the box are not strong enough for this. For this reason, BNC-connectors with flange should be used, which are then mounted on the base plate of the filter box.

1.2. Spurious Resonances

Line circuits always have several resonances. Without capacitive load, such resonances will occur at all odd multiples of $\lambda/4$. In the case of the 2 m bandpass filter the first spurious resonance was in excess of 1 GHz due to the large capacitive shortening of the line circuit, and was therefore of no importance.

In the case of the first prototype of the 70 cm filter, approximately the same line length was used as on 2 m but the capacitive loading was reduced. The first spurious resonance was in the order of 1300 MHz, in other words at the third harmonic of the 70 cm band. It was possible using a low inductive grounding of the trimmer capacitors for this resonance to be shifted to approximately 1700 MHz, which is in the order of the fourth harmonic. All attempts to suppress this spurious resonance were without success in the case of this simple, symmetrical filter construction. In order to ensure that this resonance was at least between the fourth and fifth harmonic, it was only possible for the inner conductor to be shortened slightly and to accept a slightly higher insertion loss.

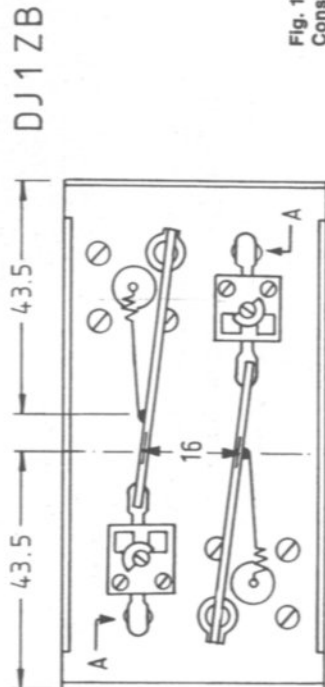

Fig. 1:
Construction of the filter

If a Gunn element is placed in a suitable position in the resonator, it will energize this oscillation. The resulting frequency is primarily determined by the geometric dimensions of the cavity. The capacitances and inductances of the Gunn element also have a certain, but relatively small effect. Since these are dependent on the operating voltage, they can be used for electronic tuning of the oscillator. If the oscillator is to be tuned over wider frequency ranges, it will be necessary to vary the dimensions of the resonator. Since this is difficult mechanically, it is usually the "electrical dimensions" that are altered, for example, by inserting a metal pin. This increases the inductance of the resonator; if, on the other hand, a dielectric pin is inserted into the resonator, this will alter the capacitance. A change of the resonant frequency of the resonator will take place in both cases. Experiments have shown that when using metal screws for tuning this can often lead to frequency jumps due to contact difficulties to the outside of the cavity, which can only be avoided when using a rather extensive construction. Teflon (PTFE) screws have been found to be very suitable, and allow a very clean, continuous tuning with high reproducibility. The loss of other plastic materials is usually too high and the oscillator will often not even oscillate.

Figures 12 and 13 show a Gunn oscillator constructed according to this principle. It is based on a recommendation of Dr. Dain Evans, G 3 RPE.

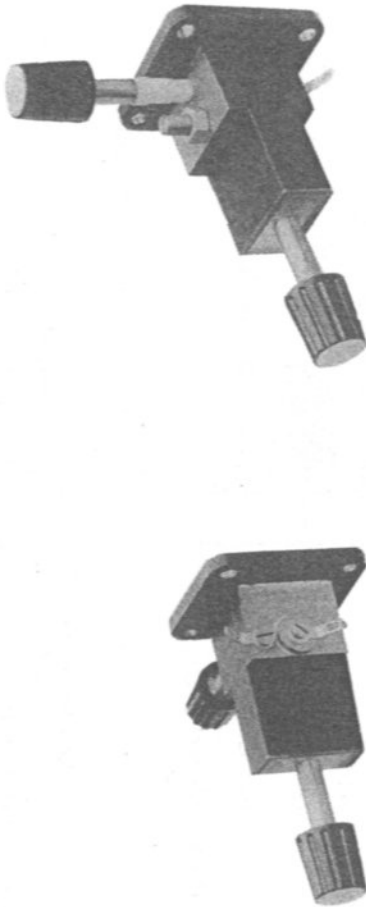

Fig. 12: Gunn oscillator with dielectric tuning

One of the two conductive walls has been removed and forms an aperture (iris), through which the RF-energy is fed to the waveguide. The second panel is variable and is used for adjusting the resonance. The dimensions are critical, and any deviations can cause large frequency deviations. The resonator can either be made from a piece of waveguide or soldered together from individual pieces of brass plate. The latter is somewhat difficult due to the large amount of soldering. The metallic mass of the resonator should be as great as possible in order to ensure a good short-term stability with respect to temperature fluctuations.

Since the Gunn element is extremely low-impedance in operation, it virtually represents a short-circuit for the waveguide. This means that it must be virtually mounted on the short-circuit panel. Since this is not possible for mechanical and electrical reasons, the described

A TRANSCEIVER FOR 10 GHz

Part 2

by B. Heubusch, DC 5 CX · Dr. Ing. A. Hock, DC 0 MT · H. Knauf, DC 5 CY

2. GUNN OSCILLATOR

The microwave oscillator is the main module of any transceiver for the 10 GHz band. In order to obtain long, line-of-sight paths, 10 GHz transceivers are practically only used in the portable mode. This means that only batteries can be used for the power supply, and that only semiconductor elements can be used. In principle, a Klystron could be used, but is not considered here due to the extensive power supply required.

Fundamentally speaking, there are two main methods of obtaining a frequency in the 10 GHz band:

- Frequency multiplication from the 2 m or 70 cm band, e.g. $144 \text{ MHz} \times 72 = 10368 \text{ MHz}$
- Self-excited oscillators in the same GHz band

The first possibility is very extensive and is quite difficult due to the amount of noise that increases with each frequency multiplication. For this reason, it is not considered here. The second method can be realized easily using a Gunn oscillator and provides a sufficiently stable frequency with a minimum of effort. The operation of the Gunn element is well known and is therefore not to be discussed in detail here. A very simple microwave oscillator can be constructed using a Gunn element whose output power and frequency stability is more than sufficient for communications in the 10 GHz band.

A cavity resonator is obtained when a waveguide is closed using a conductive panel. The length of this resonant cavity should correspond to half a wavelength. When energized with a wave, both current and voltage field (or field-strength field) are formed as shown in Figure 11.

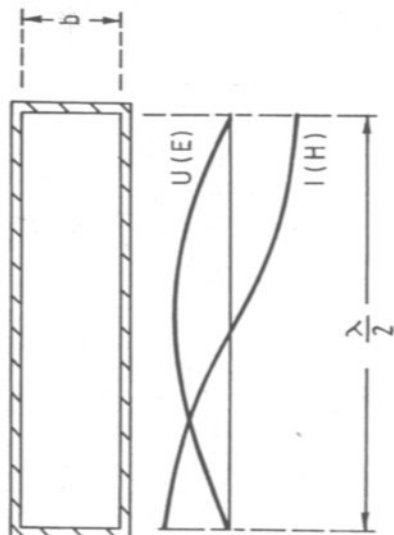

Fig. 11:
Cavity Resonator with current
and voltage distribution
(field strength distribution)

2. CONSTRUCTION

The same silver-plated box is used for the 70 cm filter as for the 2 m filter described in (1). The dimensions are 94 mm x 50 mm x 25 mm high. The location of the parts is given in Figure 1. The two line circuits are constructed from 2 mm diameter, silver-plated copper wire. For a bandwidth of 10 MHz, they are spaced 16 mm from another. The input and output coupling is made using 1 mm dia. silver-plated copper wire. This input coupling is placed from the input or output socket to the 50Ω position on the resonant line, where it is soldered into place. A small coil (3 turns, 3 mm inner diameter, approx. 4 mm long) is to be found at one end of the input and output coupling that is soldered to the inner conductor of the BNC connector. These inductances represent filters for higher frequencies.

Silver-plated solder tags are used for the low-inductive grounding of the trimmers. These tags are screwed to the base plate and bent back over the nut as shown in Figure 2. After this, the trimmers are mounted into place. The connection of the rotating plates is then connected to the bent solder tag and soldered into place.

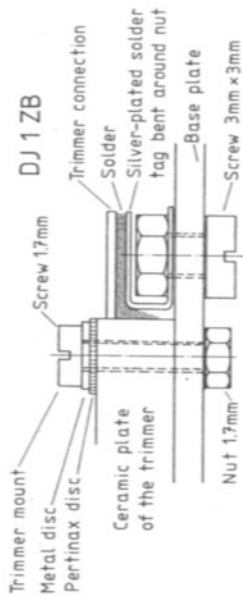

Fig. 2: Construction details of the low-inductive grounding of the trimmer at position A in Fig. 1

The cold end of the line circuits is slightly flattened and placed into bent silver-plated solder tags. These are held in place by the inner mounting screws of the BNC connectors. The line circuits and solder tags are then soldered together. The spacing between the two line circuits is adjusted easily by bending the solder tags as required. The required holes in the base plate are shown in Figure 3, and Figure 4 gives the position of the alignment holes in the cover plate.

2.1. Main Components

- 1 Filter box, silver-plated, type 94.60.0
- 4 Solder tags
- 2 air-spaced trimmers 5 pF for chassis mounting
- 2 coaxial sockets type BNC with flange
- Silver-plated copper wire of 2 mm dia. and 1 mm dia.

FURTHER DATA FOR CONSTRUCTION OF HORN ANTENNAS FOR THE 10 GHz BAND

by T. Köiplin, DK 1 IS

Several mechanical dimensions were given in (1) for the construction of horn antennas for the 3 cm band. Construction just using these dimensions is not simple. Several other values are required for cutting the plate and bending. These values are to be given in the following table. They are based on information given in (1) and are thus valid for a mean operating frequency of 10.3 GHz. The feed is made with a WR 90-waveguide, which has the inner dimensions of $a = 22.86$ mm, $b = 10.16$ mm.

Internal Dimensions of Horn Radiators for 10.3 GHz

Gain dB	Side A mm	Side B mm	Length L mm	Height H _A mm	Height H _B mm	Angle α degree	Angle β degree	Side Length mm
14	68.2	50.5	26.2	33.1	34.6	55.6	59.8	40.1
15	76.5	56.7	36.5	43.4	45.3	58.2	62.8	50.9
16	85.8	63.6	49.8	56.5	58.9	60.9	65.6	64.7
17	96.3	71.3	66.7	73.4	76.1	63.4	68.1	82.1
18	108.1	80.0	88.5	95.1	98.2	65.9	70.4	104.2
19	121.2	89.8	116.2	122.8	126.2	68.2	72.5	132.3
20	136.0	100.8	151.6	158.2	161.8	70.3	74.4	168.0
21	152.6	113.1	196.6	203.2	207.0	72.3	76.0	213.3
22	171.3	126.9	253.7	260.3	264.3	74.1	77.5	270.7
23	192.2	144.3	326.2	333.0	337.0	75.7	78.7	343.6
24	215.6	159.7	418.1	424.7	429.1	77.2	80.1	435.5
25	241.9	179.2	534.5	541.1	545.6	78.6	81.2	552.1

DK 1 IS

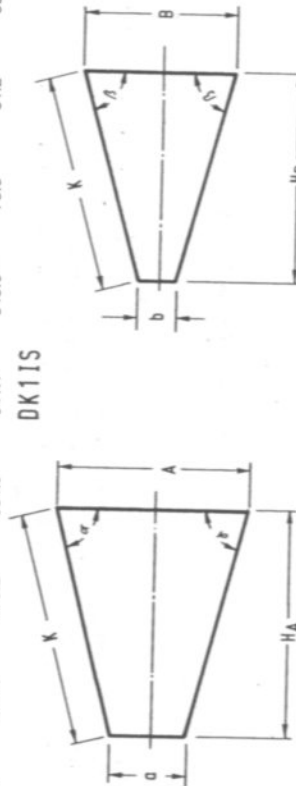

The calculations were made with the aid of a programmable calculator SR 56, and the values have been rounded for practical application. A 20 dB horn has been constructed according to these dimensions using a double-bent plate and a cover that has been soldered into place. In order to ensure a universal validity, more data is given than absolutely necessary for construction of the horn antennas.

REFERENCES

- (1) B. Heubusch, Dr. Ing. A. Hock, H. Knauf: Introduction to Microwave Techniques and a Description of a 10 GHz Transceiver VHF COMMUNICATIONS 9, Edition 2/1977, Pages 66 - 70

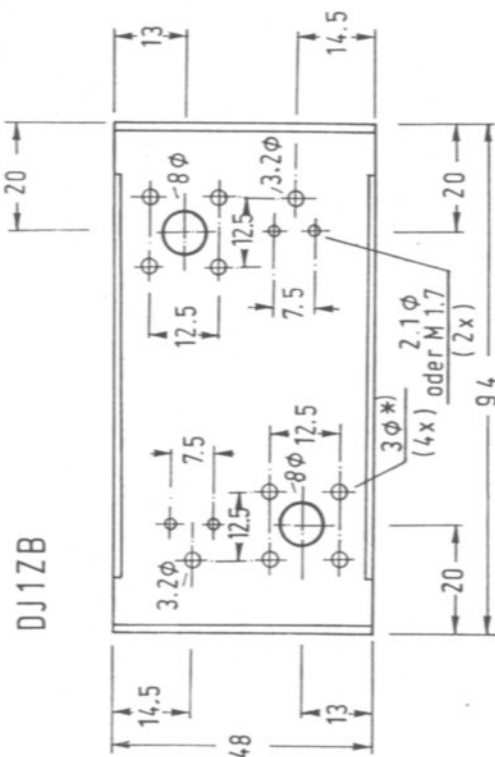

Fig. 3: Holes in the base plate ($x = \text{dia.}$ to suit the coaxial connectors used)

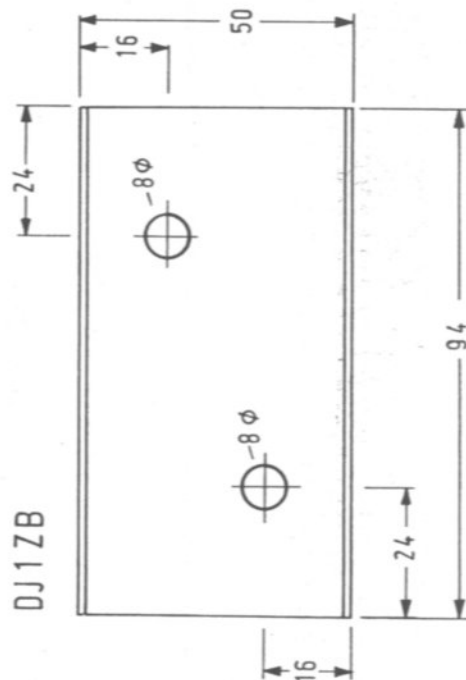

Fig. 4: Alignment holes in the cover

3. ALIGNMENT

The same alignment method should be used as was described for the 2 m bandpass filter in (1). Figure 3 shows the selectivity curve as measured on a swept-frequency system when aligned for minimum VSWR in the range of 430 MHz to 440 MHz.

The large reflection-free antenna measuring range of the German Post Office was sometimes available for exact measurements. A typical example is that a 2λ long uniform Yagi constructed according to data given by Ehrenspeck indicated a gain of 11.0 dB and thus showed only a deviation of 0.15 dB from the nominal value given in Figure 2. A 10-element Yagi of the same length derived from this showed a gain of 11.5 dB with a beamwidth increase from 34° , with minor lobe suppression increased by nearly 10 dB. In comparison, a series produced antenna available on the market of twice the length only provided 0.5 dB more gain.

4. REFERENCES

- (1) H. Yagi: Beam Transmission of Ultra Short Waves
Proc. IRE, June 1928, Pages 715 - 741
- (2) H.W. Ehrenspeck, H. Pöhler: A New Method for Obtaining Maximum Gain from Yagi Antennas
IRE Trans.Ant.Prop, October 1959, Pages 379 - 386
- (3) A. Heilmann: Antennen I - III
BI-Hochschultaschenbücher
- (4) C.A. Chen, D.K. Cheng: Optimum Element Lengths for Yagi-Uda Arrays
IEEE Trans.Ant.Prop, January 1975, Pages 8 - 14
- (5) C. Greenblum: Notes on the Development of Yagi Arrays
QST, August 1956, Pages 11 - 17, 114, 116
- (6) H.S. Brier, W.I. Orr: VHF Handbook for Radio Amateurs
Radio Publications, Wilton, Conn.
- (7) J.O. Spector: An Investigation of Periodic Rod Structures for Yagi Aerials
Proc. IEE Part B, January 1958, Pages 38 - 44
- (8) Chen-To Tai, C.S. Pereira: An Approximate Formula for Calculating the Directivity of an Antenna
IEEE Trans.Ant.Prop, March 1976, Pages 235 - 236
- (9) J.H. Bojlsen, et al: Maximum Gain of Yagi-Uda Arrays
Electronics Letters, September 1971, Pages 531 - 532

OSCAR AMATEUR RADIO SATELLITES

by S. Caramanolis

English edition with 202 pages of informative reading, illustrations, formulas, tables etc. Includes: Information on natural and artificial satellites and their orbits, as well as fundamentals of telecommunications via satellites. Furthermore, detailed information is given on past and future OSCAR satellites. Available from the publishers of VHF COMMUNICATIONS.

Anticipated price incl. postage DM 22.—

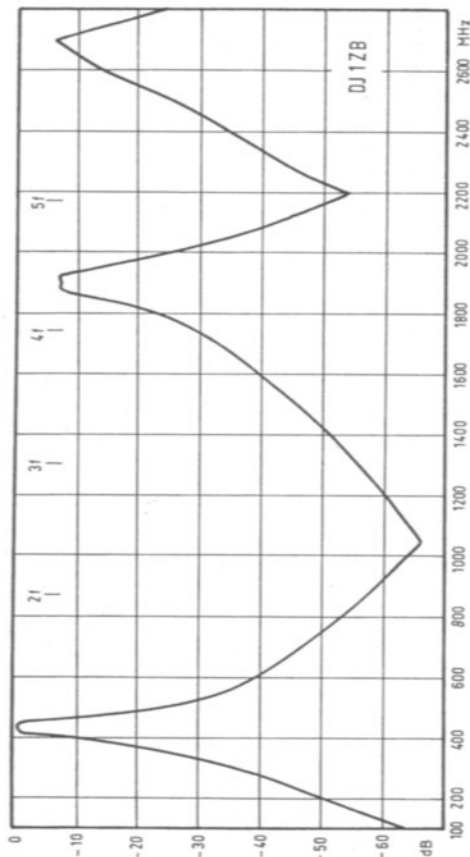

Fig. 5: Passband curve of the 70 cm bandpass filter

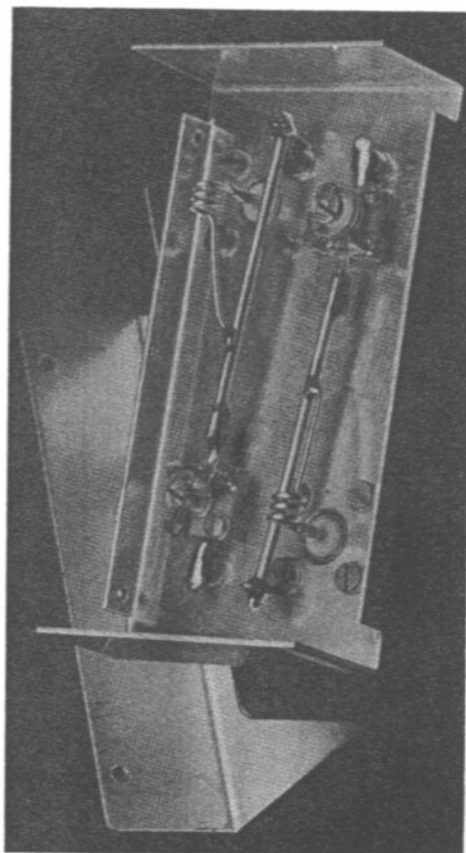

Fig. 6: Photograph of one of the author's prototypes

3.1. Filter Characteristics

As can be seen in Figure 5, the second and third harmonic of the 70 cm band are suppressed by more than 50 dB. Sufficient suppression is also given for the fourth and fifth harmonic. These are dependent on the spurious resonance at 1900 MHz, which will be shifted somewhat if there are any differences in the mechanical construction. This filter represents the optimum of what can be obtained with metal plate and wire.

Spurious resonances have been a problem with earlier publications and descriptions of filters with resonant lines (References 2, 3). The rejection in excess of 1700 MHz could only be improved by providing a coaxial low-pass filter with a cut-off frequency in this order.

It will also be seen in Figure 5 that the filter also suppresses all sub-harmonics of the 70 cm band, as well as any unwanted harmonics of the 2 m band. This advantage of the bandpass filter with respect to a low-pass filter is especially important for transmitters using a frequency multiplication principle. In critical locations, the suppression of the TV bands III and IV/V could be of assistance.

The insertion loss of the filter amounts to 0.4 dB. The 3 dB frequencies are in the order of 415 MHz and 450 MHz. A photograph of one of the author's prototypes is given in Figure 6.

4. REFERENCES

- (1) H.J. Brandt: A Simple Bandpass Filter for the 2 m Band
VHF COMMUNICATIONS 7, Edition 4/1975, Pages 244 - 249
- (2) H.J. Dohlius: Coaxial Low-Pass Filters for VHF and UHF
VHF COMMUNICATIONS 2, Edition 3/1970, Pages 166 - 178
- (3) K. Maiwald: A Bandpass Filter for 145 MHz using Printed Inductances
VHF COMMUNICATIONS 1, Edition 4/1969, Pages 205 - 208

NEW !

POLARISATIONS SWITCHING UNIT for 2m CROSSED YAGIS

Ready-to-operate as described in VHF COMMUNICATIONS. Complete in cabinet with three BNC connectors. Especially designed for use with crossed yagis mounted as an »X«, and fed with equal-length feeders. Following six polarisations can be selected: Vertical, horizontal, clockwise circular, anticlockwise circular, slant 45° and slant 135°.

VSWR: max. 1.2
Power: 100 W carrier
Dimensions: 216 by 132 by 80 mm.
Insertion loss: 0.1 to 0.3 dB
Phase error: approx. 1°

U K W - T E C H N I K · Hans Dohlius oHG
D-8523 BAIERSDORF · Jahnstraße 14
Telephone (09133) - 855, 856 · Telex: 629 887

Bank accounts: Postscheck Nürnberg 30 455 - 858
Commerzbank Erlangen 820-1154

Since $P = P_H + P_N$ is constant, only a correspondingly reduced component of the total energy is available for the main beam, and the gain will be reduced to the same ratio.

The decrease in gain amounts to:

$$R = \frac{G}{G_{\text{red}}} = 1 + \frac{S_N}{N_N \times S_H}$$

With our example with $S_N/S_H = 5.6$, the following is valid:

N_N	R
5.6 (7.5 dB)	2.0 (3.0 dB)
10 (10.0 dB)	1.6 (2.0 dB)
20 (13.0 dB)	1.3 (1.1 dB)
50 (17.0 dB)	1.1 (0.5 dB)

It will be seen that when the minor lobe suppression is only 7.5 dB as in this case, half the energy will be »lost« in the minor lobes and the maximum gain will be reduced by half.

If one assumes the following data for the prototype antenna: $\varnothing E = \varnothing H = 24^\circ$, and $N_N = 13$ dB, the following gain calculation will result:

$$G_i = 55.7 = 17.5 \text{ dB (ref. isotropic radiator)}$$

$$G_D = G_i - 2.14 \text{ dB} = 15.36 \text{ dB (ref. dipole)}$$

$$G_{D \text{ red.}} = G_D/R = 14.26 \text{ dB (ref. dipole)}$$

This value coincides well with the measured gain values of long Yagi antennas. For clarification, it should be noted that the above example is very typical, however, the position and width of the minor lobes vary. The tendency is, however, very clear: the effect of the minor lobes increases together with the directivity. It is also not possible for the back beam and higher-order minor lobes to be always neglected.

Practical experience gained since firstly writing this article tend to indicate that the gain calculation according to the Tai/Pereira expression (8) are somewhat low. The gain formula according to Kraus given in the same paper [$G \approx 4 \pi (\varnothing_1 \times \varnothing_2)$] seemingly coincides with the measurements more accurately. In the above example, $G_{D \text{ red.}}$ would be 15.34 dB.

3.5. Additional Details

When plotting the polar diagrams and making comparative antenna measurements, it is very important that a good matching is made. Most receiver inputs cause a considerable mismatch to the feeder which can cause a detuning effect on the antenna when using short feeder lengths. This can be avoided when using a 10 dB attenuator.

The author used an experimental arrangement for the preliminary experiments using an aluminium boom of U-shaped profile. The elements were soldered into brass blocks and could be shifted along the boom. The dimensions are very handy when these experiments are made in the 70 cm band. The determined lengths and spacings were then filed in a card index.

3.4.1. Effect of the Minor Lobes on the Gain

The basis of all gain estimates taken from the polar diagram is the beamwidth \varnothing of the main beam (angle between the 3 dB points). The antenna is then assumed to be in the center of a sphere and the ratio of the surface illuminated by the main beam to the surface of the complete sphere (isotropic radiator) is established. In the case of the same input power, and negligible minor lobes, the gain coincides to the reciprocal of the surface ratio.

Since the energy flow density is not constant within the main lobe, corrections will be required for the effective surface area according to the assumed shape of the beam. The latest gain estimation formula given in (8) is as follows:

$$G_i = 32 \ln 2 / (\varnothing^2 E + \varnothing^2 H)$$

In order to obtain some idea of the magnitude of the losses caused by minor lobes, a similar consideration was attempted for a typical Yagi diagram (see Figure 6).

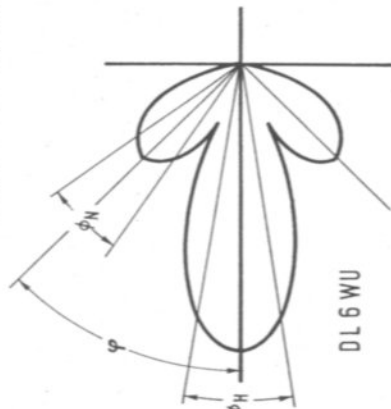

Fig. 6:
Typical diagram
of a Yagi antenna
with one minor lobe

Assumed is a main beam of $\varnothing_H = 24^\circ$ (3 dB points at $\pm 12^\circ$) and minor lobes with a maximum at $\varphi = \pm 36^\circ$ and $\varnothing_N = 12^\circ$. The diagram is assumed to be rotationally symmetrical with respect to the axis $\varphi = 0^\circ$, which is virtually true for long Yagi antennas. The area S on the surface of the sphere for the beamwidth can be calculated as follows: $S = 2\pi(1 - \cos \varphi)$

$$\begin{aligned} \text{Main beam:} & \quad \varphi = 12^\circ; S_H = 0.138 \\ \text{Minor lobe:} & \quad S_N = S_{42^\circ} - S_{30^\circ} = 0.77 \end{aligned}$$

This means that the minor lobes cover 5.6 times the surface area of the main beam! Since one can assume the minor lobe to be in the form of a funnel around the narrower main beam, this is not surprising.

In order to keep the calculation as simple as possible, the 3 dB surface has been assumed to be the effective surface, however, since only the ratio of the surfaces to another is of interest, it is assumed that the error is not important.

The total energy flow P of the antenna is distributed onto the main lobe (P_H) and the minor lobe (P_N) in relationship to their surfaces multiplied with the value of the minor lobe suppression (N_N), thus $P_H/P_N = N_N \times S_H/S_N$.

YAGI ANTENNAS

Principle of Operation and Optimum Design Criteria

by G. Hoch, DL 6 WU

Yagi antennas are well known in the VHF and UHF field since they allow a directional antenna with reasonable gain to be obtained in a simple manner. However, one is often disappointed with home-made Yagis, and even sometimes with those available on the market. This article is to show how design errors can be avoided, and what performance is to be expected.

1. UNIFORM YAGI ANTENNAS

This type of antenna was originally described by H. Yagi in 1928 (1), and possessed nearly all the features of modern long Yagi antennas. The theory of operation was not understood until much later. One of the best works regarding this antenna was published in 1939 by Ehrenspeck and Pöhler (2); they published measured values of extraordinary precision. Ehrenspeck and Pöhler showed experimentally that a radio wave is propagated along a Yagi structure with reduced phase speed, and exits the antenna in a similar manner as if it were exiting a tube. The director chain has the behaviour of an artificial dielectric, and there is a direct similarity to dielectric antennas (3).

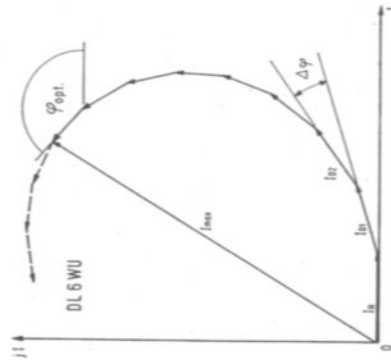

Fig. 1:
Vector diagram
of the field strength
in axial direction
of a Yagi antenna
(I_0 : current in the radiator,
 I_D : currents in the directors)

The vector diagram for the field strength at a distant point on the antenna axis is also very informative. It is proportional to the resulting vector of the currents in the individual elements. Since the current and phase angles in a parasitically energized antenna cannot be selected at will, the diagram given in Figure 1 does not allow any quantitative information. However, the illustration shows clearly that the resulting vector will not be increased after a certain point by adding further elements when the phase angles are given, but will even decrease.

The delay component of an element and the current energized into it are both altered together with its length, which means that two demands are opposite in the case of long antennas: in order to limit the phase shift, it is necessary for the elements to be shortened until finally no noticeable current is able to flow. This means that the length and gain of a Yagi antenna is limited.

Ehrenspeck and Pöhler, as well as most of the other antenna specialists, examined uniform Yagi structures, that is antennas having constant director spacings and lengths. The following can be summarized for this type of antenna:

1. There is an optimum value of the phase speed and thus the total delay of the wave front for each antenna length. The most favorable delay increases with the antenna length, however, only up to a value of approximately 105° or 0.3λ . This is obtained at an antenna length between 3λ and 4λ and remains constant for longer antennas.
2. The phase speed V along a director chain is dependent on the length, thickness and spacing of the elements. There are an infinite number of combinations that lead to the most favorable value of V . When using element spacings of 0.4λ and less, the same maximum value of the gain will be achieved.
3. The maximum gain possible is only dependent on the antenna length if the most favorable value of V has been obtained.
4. No noticeable gain increase will be observed at greater antenna lengths than 6λ ; the maximum gain value of a conventional Yagi structure is in the order of 14 dB. **Figure 2** shows this relationship, as well as measured values of several antennas available on the market, and also some home-made antennas. The number given in the designation gives the number of elements.

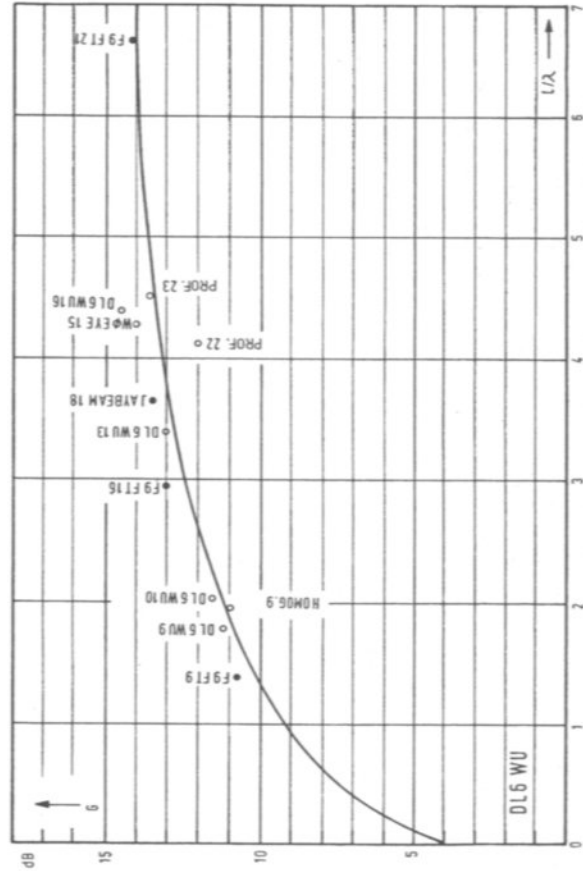

Fig. 2: Gain of Yagi antennas as a function of their length measurements: ● DL 1 BU; ○ DL 6 WU

Two simple methods have been proved in practice: the antenna to be optimized is used as transmit antenna connected to a very long feeder (3 dB loss or more), or as receive antenna connected to a good terminating resistor. In both cases, the antenna is trimmed for maximum received voltage. The fine alignment is then made with the aid of a reflectometer, if required. In this way, it is not possible for the antenna to be matched correctly, but be completely detuned.

3.4. Gain Measurements

Exact measurements on antennas are very difficult, especially gain measurements. The demands made on such measurements are given in IEC 138 and DIN 45003. Especially the measures given in this standard to avoid interfering ground reflections are usually completely ignored in the case of amateur measurements. Usually, it is only possible for us to be able to measure the matching, and the horizontal polar diagram, e.g. the E-diagram in the case of horizontal polarisation. Since Yagi antennas possess a relatively close relationship between the E and the H-diagram as can be seen in **Figure 5**, this allows a certain criterion for estimating the gain. If the measured values are, however, placed in the gain nomogram (6), one will obtain a theoretical upper limit of the gain, but these values are most certainly too optimistic for practical applications, since the diagram assumes no-loss antennas without minor lobes. It is especially with very long antennas that the minor lobes increase with length and thus the losses.

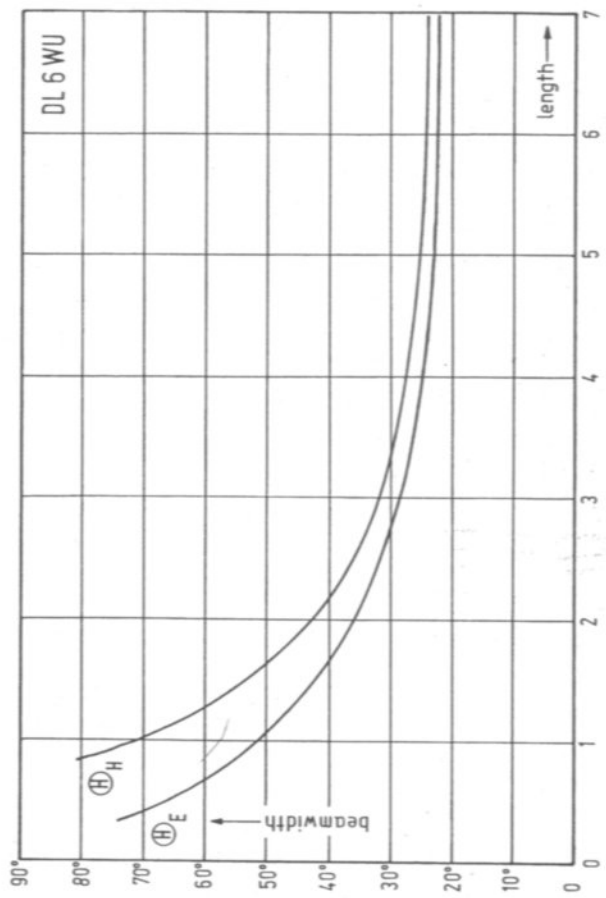

Fig. 5: Beamwidth of Yagi antennas as a function of the antenna length (mean values from numerous references and measured values)

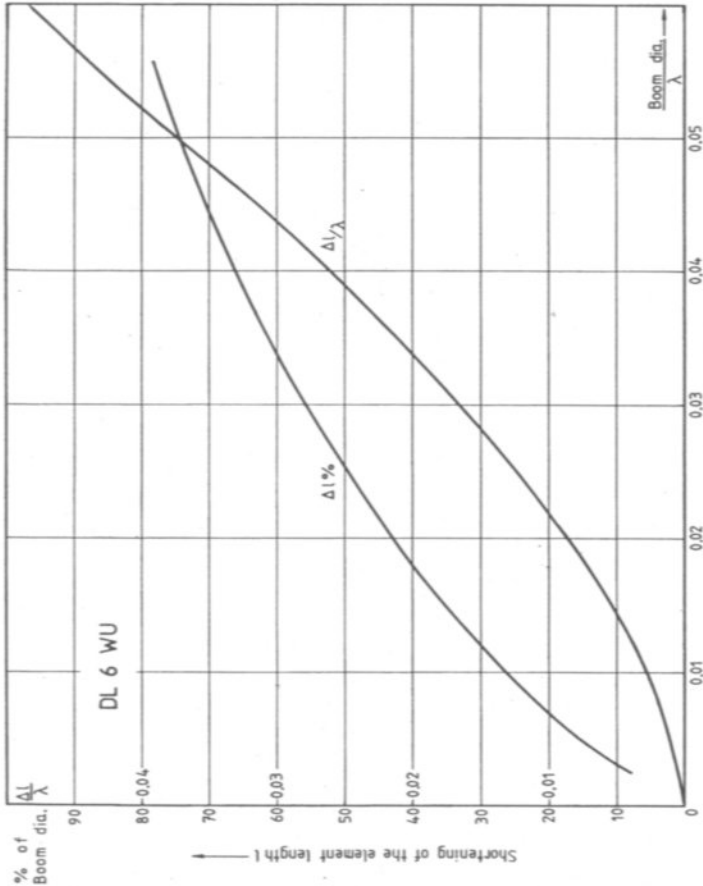

Fig. 4: Influence of metallic boom on resonant length of elements piercing it (median of measurements on .0029 λ , .0075 λ and .0145 λ dia. elements)

3.3. Matching

The matching of the radiator to the feeder cable is a critical point in the construction of parasitic antennas.

Many parameters have an effect on the radiation resistance of the dipole element: its length, length and spacing of the adjacent elements and also their position to another. Only those directors that are spaced further away from the element (director 4 and onward) have relatively little effect. The relationship is extremely complex. Generally speaking, the feed point impedance of the radiator will be reduced on decreasing the spacing of the neighbouring elements, and the intrinsic resonance of these elements approaches the designed frequency. However, under certain circumstances, this tendency can be reversed with very small element spacings. A first director in the direct vicinity of the radiator will have a similar effect as an element of a folded dipole. It is possible with correct selection of the parameters for a folded dipole to be matched to either 240 Ω or direct to 75 Ω . It is only necessary for a systematic experimentation to be carried out.

2. NON-UNIFORM YAGI ANTENNAS

Since the above information is valid for uniform Yagi structures, this led to experimentation with non-uniform antennas to obtain further improvements. Due to the large number of parameters, further experimentation is very difficult. However, it has been found that it is more favorable for the delay to be concentrated in the vicinity of the radiator and this to be reduced towards the end of the antenna (3, 4). The current component of the elements should also be reduced together with the distance from the radiator (4). Both effects can be obtained together when using a continuous reduction of the element lengths and increase of the spacings.

These measures have the effect of reducing the minor lobes and widening the main lobe with respect to these of a uniform Yagi antenna. Maximum gain is obtained as a compromise between directivity and suppression of the minor lobes.

It is also necessary for the discontinuities at the open end of the antenna and at the radiator to be compensated since they can lead to interference effects on the travelling waves that are prevalent with well-designed antennas.

It is true that the above considerations have been partially assisted by computer simulation, however, it has been found that further experimentation is always necessary. For this reason, the proved knowledge about uniform antennas, which are a good approximation also for the mean values of non-uniform antennas, are extremely useful for use as basic values.

Even though, it seems that the maximum increase in gain to be expected is approximately 1 dB, over that given by Ehrenspeck and Pöhler, even after all improvements have been made. This means that the maximum gain that can be achieved with a single, conventional Yagi antenna, should not be much higher than 15 dB.

This shows that extreme caution is required when higher maximum gain figures are given in some publications, e.g. (5, 6). Usually these are then gain figures that have been calculated from the beamwidth, or values that have been falsified by ground reflection. Errors in the order of 3 dB are quite common. Gain measurements are to be discussed later in this article.

After completing the manuscript for this article, the information given in (9) became available to the author. In this article, controlled end reflection was used to obtain a further, small increase of gain, however, the design seemed to be very critical.

3. HOME CONSTRUCTION OF YAGI ANTENNAS

Home construction of antennas is still very rewarding, especially when large antenna arrays are to be constructed. Model antenna systems on the 70 cm or higher bands simplify the design, and the final results can be recalculated for the required frequency. However, anyone who wishes to construct well-known designs, to modify them, or to recalculate these for other frequencies should know the effect of all construction parameters on the operation of the antenna. Seemingly slight deviations can cause a complete failure!

The important dimensions are: antenna length, element spacings, element lengths, element diameter, and also the thickness of the boom.

3.1. Element Length and Diameter

Figure 3 shows the dependence of the element length as a function of the element diameter for reflector, radiator and directors (mean value for all directors), when the other dimensions of the antenna are already known. It may be surprising to see that it is not the antenna length and element spacing that it used as parameter but only the number of elements.

The reason for this is in the reciprocal relationship between the phase delay and element spacing (7). Since the most favorable delay remains practically constant with long antennas (as was already mentioned in section 1), the curves for the same number of elements coincide. This is no longer valid for short antennas (≈ 1.52) but the approximation is useful in all cases.

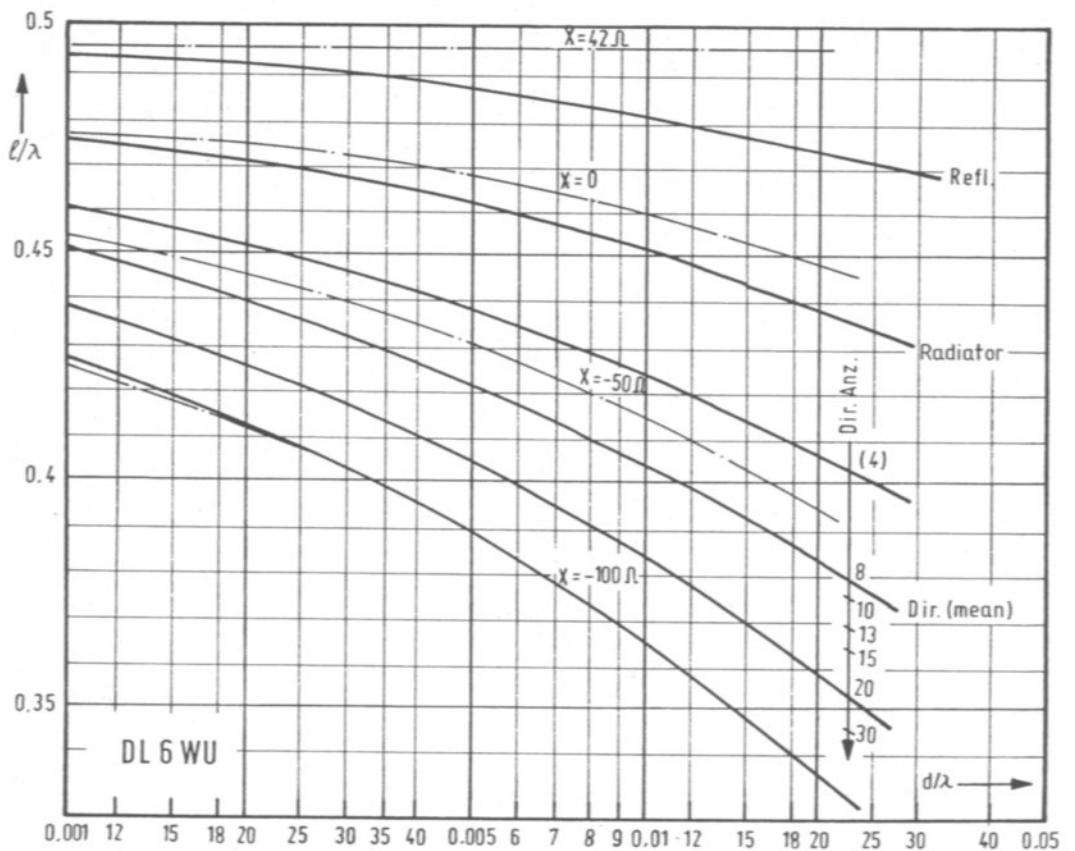

Fig. 3: Optimum length of Yagi elements as a function of their diameter
Dashed lines: curves of constant reactance

It will be seen that the element diameter dependence of the director length increases with the number of elements, and is far greater than that of the radiator and reflector. This is because the radiator and reflector are resonant circuits operated virtually in resonance, whereas the directors are strongly detuned capacitively. On increasing the diameter, the Q will decrease, which means that the detuning must be further increased in order to obtain the same phase position. When using the semi-logarithmic scale used here, it is easy to see that a shortening of approximately 7% in the case of the radiator and reflector and approximately 14% in the case of the directors is required when increasing the element diameter by ten times.

The curves of constant reactance of an individual dipole element, as taken from an engineering table, are given in Figure 3 as dashed lines. The solid lines are experimentally derived curves of constant element performance. It will be seen from the great similarity in the curve that it is mainly its reactance that is important for the operation of an element. This means that when it is replaced by an element having a different diameter, the original reactance must be restored. The real component of the impedance, e.g. loss and radiation resistance, have a very small dependence on the length and diameter in the vicinity of $\lambda/2$.

The length/diameter diagram is therefore very advantageous when making calculations for elements of differing diameters: the values of length and diameter (l_1, d_1) should be found for the known element, through this point another curve is interpolated parallel to the nearest curves given in the diagram and the new values for the diameter d_2 and length l_2 read off at the required point.

If the element lengths differ noticeably, this calculation must be made for each element. It is usually sufficient to calculate the difference between the old and new average length and to correct the individual element lengths correspondingly. By the way, the length tolerance of an individual element is relatively large as long as the mean value is maintained within about 0.5%.

No significant effect of the element diameter on the gain could be observed with antennas up to 4λ . Diameters from 0.003λ to 0.015λ were examined. However, a loss of gain was observed with very thin brass elements, which was probably caused by skin effect losses.

3.2. Effect of the Boom Diameter

Virtually no information can be found on the effect of the element mounting. Sometimes it is mentioned that approximately 2/3 of the boom diameter should be added for elements that pass through a metallic boom.

Experiments were firstly made by comparing calculated and measured resonance positions of various antennas in order to obtain the required information, however, this was really inaccurate and only showed a general tendency.

For this reason, the author decided to carry out his own measurements. The detuning of a matched three-element antenna on altering the diameter of the (long) boom in the vicinity of the director was compensated for by retuning the director. This resulted in the curve given in Figure 4, which should be sufficiently accurate for practical application. No effect of the shape of the boom (circular, rectangular, or U-shaped) could be found. The element diameter seems to have little influence as long as it remains below boom diameter.